

2026

TARIFA PVP

2ª edición

11 de mayo

italsan

 **TRIPLUS**

 **PP3FIREPLUS**

 **SILERE**

 **PPECOFORTE**

 **PP/PP3**

 **WHITEMARINE**
UV RESISTANT



**Sistemas de tuberías para
evacuación insonorizada**

Índice

Sistema de tuberías y accesorios en polipropileno triple capa TRIPLUS

5 Sistema de evacuación insonorizada. Características e instalación

7 Tubería

8 Accesorios

14 Adaptadores entre distintos sistemas

Soluciones en la instalación

17 Curva 87° 30'

18 TRIPLUS Multiconexión

19 TRIPLUS bote sifónico inspeccionable

20 Válvula de admisión de aire AIRVAL

21 Collarines intumescentes

21 Collarines antideslizantes

Sistema de evacuación con derivación de ventilación

23 TRIPLUS Derivación de ventilación

Tuberías en polipropileno triple capa fonoabsorbente PP/PP3 Phono

28 Sistema en PP fonoabsorbente, la alternativa al PVC. Características e instalación

30 Tubería

31 Accesorios

35 Adaptadores entre distintos sistemas

Tuberías en polipropileno triple capa fonoabsorbente FIREPLUS con clasificación B-s1,d0 según EN 13501

38

Sistema en PP fonoabsorbente, para instalaciones que exigen B-s1,d0

41

Accesorios

40

Tubería

Sistema de tuberías y accesorios en PP monocapa con carga mineral SILERE

45

Sistema en PP con carga mineral. Máximo confort acústico

48

Accesorios

47

Tubería

51

Adaptadores entre distintos sistemas

Botes sifónicos en polipropileno

53

Sifones y botes sifónicos PP

Sistema de Evacuación en PP-HM ECOFORTE

59

Tubería

60

Accesorios

Sistema de descarga WHITE MARINE para las aplicaciones navales

65

Sistema de tuberías con acoplamiento, conexiones y accesorios con características de insonorización y resistencia química y mecánica

67

Accesorios

66

Tubería



 **TRIPLUS**



Sistema de
evacuación
insonorizada

Sistema de tuberías y accesorios de polipropileno triple capa para evacuación insonorizada

El sistema TRIPLUS se compone de la tubería y los accesorios en polipropileno triple capa, con la capa intermedia en PP reforzado con carga mineral para evacuación de aguas residuales a baja y alta temperatura.

Capa intermedia

Está realizada con una mezcla de polipropileno y cargas minerales que garantiza una elevada resistencia mecánica y unas prestaciones acústicas óptimas.



Campana y espiga de acoplamiento con junta de labio

La campana y espiga de acoplamiento lleva una junta de labio que asegura la estanqueidad hidráulica y el deslizamiento del tubo por efecto de las dilataciones térmicas. Las características geométricas de la campana garantizan una colocación fácil y rápida.



Capa exterior

Garantiza una elevada resistencia al impacto y una óptima protección mecánica.

Capa interior

El interior de la tubería está constituido por una capa de polipropileno que ofrece una superficie interior muy lisa y una alta resistencia a los agentes químicos.

Características

- Sistema de unión por junta elastomérica monolabial.
- Producto conforme según norma UNE-EN 1451-1.
- Resistencia al agua caliente según DIN 1986.
- Con nivel de fonoabsorcencia 7 dB con caudal de descarga de 2 l/s según EN 14366.

Certificados de Calidad

- Certificado de calidad AENOR según UNE EN 1451-1 obtenido en la gama de tubería y en la gama de accesorios.
- Certificado Fraunhofer Nivel Presión Sonora Lsc.A según EN 14366: <10 dB con caudal de descarga 2 l/s.
- Certificado Green Building de reciclabilidad y sostenibilidad.
- Declaración ambiental de producto DAP.



Aplicaciones

- Evacuación de aguas residuales en el interior del edificio hasta 95 °C.
- Ventilación primaria, secundaria y terciaria.
- Evacuación de aguas pluviales.
- Sistemas gravitatorios industriales.
- Evacuación de condensados de circuitos de climatización.

La instalación

Sistema de unión mediante boca con junta elastomérica monolabial

El sistema **TRIPLUS** garantiza una instalación rápida y sin el uso de adhesivos, equipos eléctricos o maquinaria especial gracias al sistema de unión con junta labial.



Sistema de unión mediante manguito corredizo

El sistema **TRIPLUS** dispone del manguito corredizo, el acoplamiento idóneo que permite la unión de dos tubos. Este sistema permite la recuperación de tubos, modificación de instalación y la realización de reparaciones.



Tuberías en polipropileno triple capa evacuación insonorizada

Tubo con 1 boca

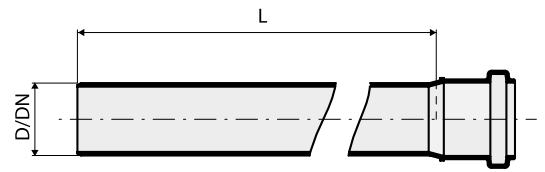

Referencia	D (mm)	DN (mm)	Espesor (mm)	L (mm)		Precio (€/ud.)
VS0650005	32	30	1,8	500	30	4,08
VS0650007	32	30	1,8	1000	24	6,36
VS0650013	32	30	1,8	3000	24	16,56
VS0650025	40	40	1,8	500	50	4,08
VS0650027	40	40	1,8	1000	20	6,36
VS0650031	40	40	1,8	2000	20	11,82
VS0650033	40	40	1,8	3000	20	17,68
VS0650045	50	50	1,8	500	35	4,41
VS0650047	50	50	1,8	1000	30	6,39
VS0650051	50	50	1,8	2000	30	13,15
VS0650053	50	50	1,8	3000	30	19,03
VS0650065	75	70	2,6	500	20	7,45
VS0650067	75	70	2,6	1000	20	10,54
VS0650071	75	70	2,6	2000	20	19,81
VS0650073	75	70	2,6	3000	20	29,45
VS0650085	90	90	3,1	500	24	9,99
VS0650087	90	90	3,1	1000	10	15,76
VS0650091	90	90	3,1	2000	10	29,90
VS0650093	90	90	3,1	3000	10	42,26
VS0650103	110	100	3,4	250	15	7,39
VS0650105	110	100	3,4	500	15	11,20
VS0650107	110	100	3,4	1000	15	17,54
VS0650111	110	100	3,4	2000	15	33,13
VS0650113	110	100	3,4	3000	15	48,05
VS0650125	125	125	3,9	500	6	15,75
VS0650127	125	125	3,9	1000	8	25,47
VS0650131	125	125	3,9	2000	8	47,05
VS0650133	125	125	3,9	3000	8	65,70
VS0650145	160	150	4,9	500	1	24,51
VS0650147	160	150	4,9	1000	6	38,14
VS0650151	160	150	4,9	2000	6	70,91
VS0650153	160	150	4,9	3000	6	100,76
VS0650167	200	200	6,2	1000	4	94,16
VS0650171	200	200	6,2	2000	4	163,04
VS0650173	200	200	6,2	3000	4	204,99
VS0650187	250	250	7,7	1000	4	155,15
VS0650193	250	250	7,7	3000	4	342,59

Referencias de tubo disponibles en stock, para otros largos de tubo consultar en atencionalcliente@italsan.com o en el 900 921 957

Accesorios en polipropileno monocapa evacuación insonorizada

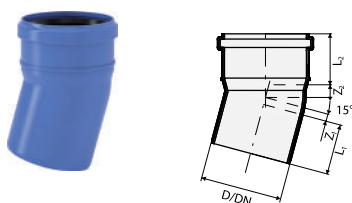

Codo 15°

Referencia	D (mm)	DN (mm)	Z1 (mm)	L1 (mm)	Z2 (mm)	L2 (mm)		Precio (€/ud.)
VS0650411	40	40	4	47	8	44	50	2,53
VS0650421	50	50	4	48	8	46	30	3,52
VS0650451	110	100	9	61	16	59	20	8,43
VS0650461	125	125	10	66	17	64	20	15,81
VS0650471	160	150	12	45	22	73	1	24,70

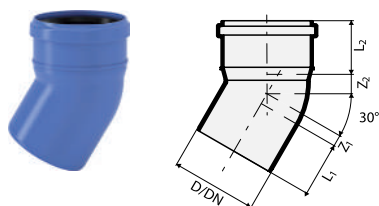

Codo 30°

Referencia	D (mm)	DN (mm)	Z1 (mm)	L1 (mm)	Z2 (mm)	L2 (mm)		Precio (€/ud.)
VS0650413	40	40	7	47	10	44	50	2,53
VS0650423	50	50	8	48	12	46	30	3,20
VS0650453	110	100	17	61	23	59	20	8,43
VS0650463	125	125	18	66	26	64	20	15,81
VS0650473	160	150	23	75	33	73	1	24,70



Codo 45°

Referencia	D (mm)	DN (mm)	Z1 (mm)	L1 (mm)	Z2 (mm)	L2 (mm)		Precio (€/ud.)
VS0650405	32	30	8	45	10	44	80	2,51
VS0650415	40	40	10	47	14	44	50	2,53
VS0650425	50	50	11	48	17	46	30	3,09
VS0650435	75	70	18	53	22	52	20	5,55
VS0650445	90	90	21	56	26	56	20	7,54
VS0650455	110	100	25	61	31	59	20	7,88
VS0650465	125	125	28	66	35	64	15	15,81
VS0650475	160	150	35	75	45	73	1	24,70
VS0650485	200	200	63	180	86	170	1	152,63
VS0650495	250	250	57	210	88	203	1	275,11

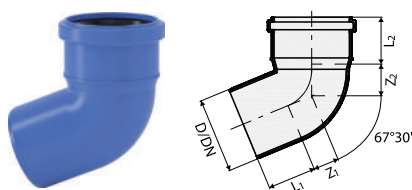

Codo 67° 30'

Referencia	D (mm)	DN (mm)	Z1 (mm)	L1 (mm)	Z2 (mm)	L2 (mm)		Precio (€/ud.)
VS0650417	40	40	15	47	19	44	50	2,70
VS0650427	50	50	18	48	22	46	30	4,36
VS0650457	110	100	40	61	45	59	20	8,91
VS0650467	125	125	43	66	51	64	15	23,17

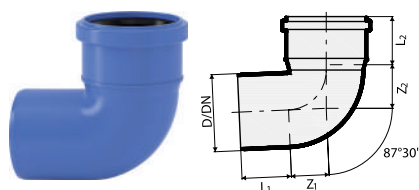

Codo 87° 30'

Referencia	D (mm)	DN (mm)	Z1 (mm)	L1 (mm)	Z2 (mm)	L2 (mm)		Precio (€/ud.)
VS0650409	32	30	20	45	19	44	60	2,70
VS0650419	40	40	22	47	25	44	50	2,70
VS0650429	50	50	26	48	30	46	30	3,43
VS0650439	75	70	40	53	43	52	20	7,24
VS0650449	90	90	46	56	51	56	20	8,03
VS0650459	110	100	57	61	61	59	20	8,43
VS0650469	125	125	62	66	70	64	10	23,17
VS0650479	160	150	78	75	89	73	1	38,31
VS0650489	200	200	148	180	172	170	1	178,08
VS0650499	250	250	122	210	163	203	1	303,39

Accesorios en polipropileno monocapa evacuación insonorizada

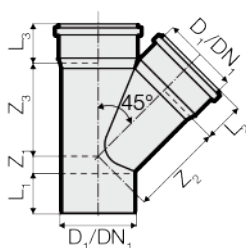

Derivación 45°

Referencia	D1 (mm)	DN1 (mm)	Z1 (mm)	L1 (mm)	Z2 (mm)	L2 (mm)	Z3 (mm)	L3 (mm)		Precio (€/ud.)
VS0650501	32	32	7	50	44	44	44	44	40	5,55
VS0650507	40	40	10	46	49	44	49	44	20	5,92
VS0650513	50	50	12	50	61	46	61	46	20	7,07
VS0650519	75	70	19	53	96	52	96	52	20	9,78
VS0650525	90	90	21	56	110	56	110	56	20	14,72
VS0650531	110	100	25	61	135	59	135	59	10	16,46
VS0650537	125	125	28	66	152	65	152	65	5	57,12
VS0650543	160	150	-	82	194	77	195	77	1	89,04
VS0650669 *	200	200	42	195	275	133	275	133	1	263,81
VS0650685 *	250	250	52	180	333	163	333	162	1	461,67

(*) Derivación manipulada

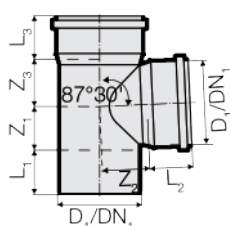

Derivación 87°30'

Referencia	D1 (mm)	DN1 (mm)	Z1 (mm)	L1 (mm)	Z2 (mm)	L2 (mm)	Z3 (mm)	L3 (mm)		Precio (€/ud.)
VS0650505	32	32	21	45	17	52	17	52	40	5,55
VS0650511	40	40	19	46	24	44	28	44	20	5,92
VS0650517	50	50	28	50	29	46	29	46	20	7,07
VS0650523	75	70	39	53	46	52	46	52	20	9,78
VS0650529	90	90	48	56	52	56	52	56	20	14,72
VS0650535	110	100	56	61	65	59	65	59	10	16,46
VS0650541	125	125	65	66	71	65	71	65	10	57,12
VS0650547	160	150	-	82	89	78	93	77	1	89,04
VS0650671 *	200	200	150	150	134	136	134	136	1	280,77
VS0650687 *	250	250	170	170	165	160	165	160	1	467,32

(*) Derivación manipulada

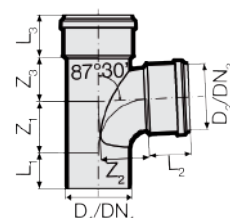

Derivación 87°30' curvada

Referencia	D1/D2 (mm)	DN1/DN2 (mm)	Z1 (mm)	L1 (mm)	Z2 (mm)	L2 (mm)	Z3 (mm)	L3 (mm)		Precio (€/ud.)
VS0650694	90/90	90/90	57	56	64	56	47	59	20	16,46
VS0650695	110/75	100/70	48	81	54	52	58	59	10	20,05
VS0650696	110/90	100/90	57	72	64	56	58	59	10	21,36
VS0650693	110/110	100/100	69	64	78	66	58	59	8	30,80

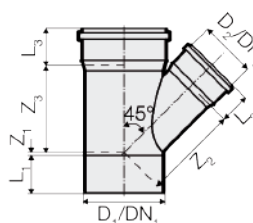

Derivación reducida 45°

Referencia	D1/D2 (mm)	DN1/DN2 (mm)	Z1 (mm)	L1 (mm)	Z2 (mm)	L2 (mm)	Z3 (mm)	L3 (mm)		Precio (€/ud.)
VS0650557	50/40	50/40	5	50	56	44	54	46	20	6,41
VS0650563	75/40	70/40	-7	46	79	44	71	52	25	9,78
VS0650575	90/40	90/40	-10	56	87	44	76	56	20	14,72
VS0650581	90/50	90/50	-9	56	90	46	83	56	20	16,46
VS0650587	110/40	100/40	-24	61	99	44	89	59	20	16,46
VS0650593	110/50	100/50	-17	61	106	46	79	59	20	16,46
VS0650599	110/75	100/70	1	61	121	52	112	59	15	16,46
VS0650605	125/50	125/50	-24	66	114	46	111	65	10	37,63
VS0650611	125/110	125/100	18	66	146	59	142	65	8	37,63
VS0650617	160/110	150/100	-	82	-	-	167	77	1	59,28
VS0650623	160/125	150/125	-	82	-	-	170	77	1	59,28
VS0650629 *	200/110	200/100	-20	150	227	64	205	136	1	140,87
VS0650633 *	200/125	200/125	-13	151	236	75	219	134	1	151,17
VS0650637 *	200/160	200/150	14	150	257	75	244	134	1	190,32
VS0650643 *	250/110	250/100	-47	180	262	64	235	162	1	250,61
VS0650647 *	250/160	250/150	-12	180	308	78	251	162	1	278,90
VS0650650 *	250/200	250/200	16	180	307	135	300	162	1	382,52

(*) Derivación manipulada

Accesorios en polipropileno monocapa evacuación insonorizada

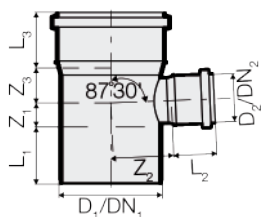

Derivación reducida 87° 30'

Referencia	D ₁ /D ₂ (mm)	DN ₁ /DN ₂ (mm)	Z ₁ (mm)	L ₁ (mm)	Z ₂ (mm)	L ₂ (mm)	Z ₃ (mm)	L ₃ (mm)		Precio (€/ud.)
VS0650567	75/40	70/40	22	53	47	44	30	52	25	9,78
VS0650579	90/40	90/40	23	56	50	44	29	56	15	14,72
VS0650591	110/40	100/40	21	61	62	44	32	59	20	16,46
VS0650597	110/50	100/50	26	61	64	46	37	59	20	16,46
VS0650603	110/75	100/70	38	61	67	52	49	59	15	16,46
VS0650691 •	110/90	100/90	56	61	90	60	65	59	10	18,57
VS0650609	125/50	125/50	28	66	68	46	36	65	10	37,63
VS0650615	125/110	125/100	58	66	72	59	64	65	8	37,63
VS0650621	160/110	150/100	55	75	93	59	71	73	1	59,28
VS0650627	160/125	150/125	64	75	93	65	79	73	1	59,28
VS0650631 *	200/110	200/100	50	150	134	64	101	134	1	192,21
VS0650635 *	200/125	200/125	57	150	135	75	99	134	1	199,75
VS0650639 *	200/160	200/150	118	150	138	76	116	134	1	207,30
VS0650645 *	250/110	250/100	70	180	145	64	77	162	1	288,30
VS0650649 *	250/160	250/150	74	180	174	78	118	162	1	316,59
VS0650651 *	250/200	250/200	95	180	160	135	138	162	1	414,56

(•) Tubo en Y simple con reducción de injerto en la derivación

(*) Derivación manipulada

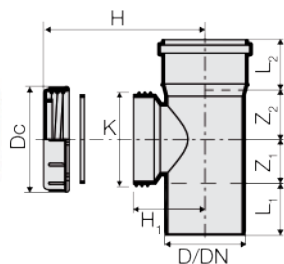

Inspección con tapón roscado

Referencia	D (mm)	DN (mm)	Z ₁ (mm)	L ₁ (mm)	Z ₂ (mm)	L ₂ (mm)	H (mm)	Dc (mm)	K (mm)	H ₁ (mm)		Precio (€/ud.)
VS0650901	50	50	36	48	35	46	65	90	74	57	20	12,62
VS0650903	75	70	40	53	43	52	85	90	74	66	20	15,44
VS0650905	90	90	49	58	55	56	90	120	105	80	20	20,45
VS0650907	110	100	55	61	65	59	100	120	105	90	15	24,04
VS0650909	125	125	65	66	71	65	105	150	128	98	10	47,04
VS0650911	160	150	64	75	75	63	125	150	128	118	1	72,42
VS0650913 *	200	200	76	145	110	135	150	150	128	142	1	263,15
VS0650915 *	250	250	81	170	113	160	165	150	128	158	1	368,70

(*) Derivación manipulada

Accesorios en polipropileno monocapa evacuación insonorizada

Derivación doble 45°

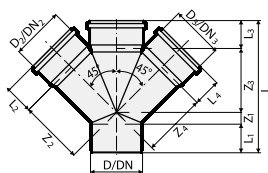

Referencia	D1/2/3 (mm)	DN1/2/3 (mm)	L (mm)	Z1 (mm)	L1 (mm)	Z2/3/4 (mm)	L2/3/4 (mm)		Precio (€/ud.)
VS0650652 *	75/75/75	70/70/70	230	-	54	96	52	1	101,24
VS0650653 *	90/90/90	90/90/90	243	-	58	110	56	1	114,36
VS0650655	110/110/110	100/100/100	280	25	61	136	59	5	32,94
VS0650658 *	125/125/125	125/125/125	319	-	72	152	64	1	160,22
VS0650660 *	160/160/160	150/150/150	394	-	75	195	77	1	254,24

(*) Derivación manipulada

Derivación doble 87° 30'

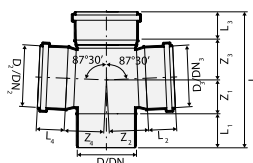

Referencia	D1/2/3 (mm)	DN1/2/3 (mm)	L (mm)	Z1 (mm)	L1 (mm)	Z2/4 (mm)	L2/4 (mm)	Z3 (mm)	L3 (mm)		Precio (€/ud.)
VS0650654	110/50/50	100/50/50	181,5	25	60	63	44	42,5	54	5	86,61
VS0650656	110/110/110	100/100/100	249	64	60	72	52	73	52	5	86,61
VS0650659 *	125/110/110	125/100/100	252	59	65	79	52	72	56	5	154,44
VS0650667 *	160/110/110	150/100/100	289	61	84	100	52	81	63	1	260,87

(*) Derivación manipulada

Derivación doble 87° 30' compacta

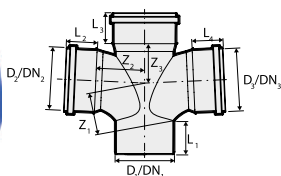

Referencia	D1/2/3 (mm)	DN1/2/3 (mm)	Z1 (mm)	L1 (mm)	Z2 (mm)	L2 (mm)	Z3 (mm)	L3 (mm)	L4 (mm)		Precio (€/ud.)
VS0652911	90/90/90	90/90/90	57	56	64	56	47	56	56	12	73,61
VS0652912	110/110/75	100/100/70	69	64	78	66	58	59	52	5	81,78
VS0652913	110/110/90	100/100/90	69	64	78	66	58	59	56	5	84,76
VS0652914	110/110/110	100/100/100	69	64	78	66	58	59	59	5	86,61

Derivación doble 87° 30' en ángulo

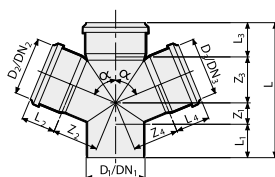

Referencia	D1/2/3 (mm)	DN1/2/3 (mm)	Z1 (mm)	Z2/4 (mm)	Z3 (mm)	L (mm)	L1 (mm)	L2/4 (mm)	L3 (mm)		Precio (€/ud.)
VS0650657	110/110/110	100/100/100	54	77	71	242	63	54	54	5	92,30
VS0650661	125/110/110	125/100/100	54	77	71	255	71	54	59	5	107,86
VS0650662 *	160/110/110	150/100/100	68	100	77	290	78	52	67	1	260,87

(*) Derivación manipulada

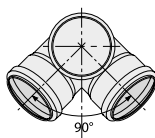

Accesorios en polipropileno monocapa evacuación insonorizada

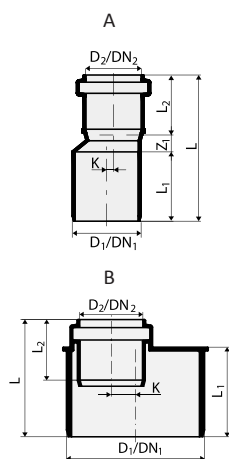

Reducción excéntrica

Referencia	Mod.	D1/D2 (mm)	DN1/DN2 (mm)	K (mm)	Z1 (mm)	L1 (mm)	L2 (mm)	L (mm)		Precio (€/ud.)
VS0650701	A	40/32	40/30	0	11	44	45	100	50	4,22
VS0650705	A	50/40	50/40	5	12	51	44	107	50	4,22
VS0650707	B	75/40	70/40	9	-	56	39	74	30	5,23
VS0650709	B	75/50	70/50	4	-	56	42	73	30	5,23
VS0650711	B	90/40	90/40	16	-	59	40	77	20	7,24
VS0650713	B	90/50	90/50	11	-	61	42	78	20	7,24
VS0650715	A	90/75	90/70	5	3	57	47	107	20	7,73
VS0650717	B	110/40	100/40	25	-	63	40	79	20	7,73
VS0650719	B	110/50	100/50	20	-	63	42	80	20	7,73
VS0650721	B	110/75	100/70	7	-	63	47	80	20	7,73
VS0650723	A	110/90	100/90	7	3	60	50	113	20	8,80
VS0650729	A	125/110	125/100	4	6	67	49	122	20	13,96
VS0650731	B	160/110	150/100	10	-	85	52	103	1	20,85
VS0650733	B	160/125	150/125	4	-	86	56	105	1	20,85
VS0650735 *	B	200/110	200/100	10	45	90	55	191	1	166,48
VS0650739 *	A	200/160	200/150	18	45	93	77	215	1	177,13
VS0650747 *	A	250/200	250/200	23	51	124	135	310	1	264,68

(*) Piezas manipuladas

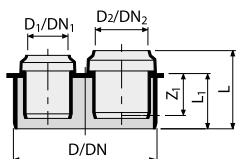

Reductor corto doble

Referencia	D/D1/D2 (mm)	DN/DN1/DN2 (mm)	Z1 (mm)	L (mm)	L1 (mm)		Precio (€/ud.)
VS0652990N	110/40/40	100/40/40	30	60	42	15	34,82

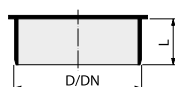

Tapón de cierre

Referencia	D (mm)	DN (mm)	L (mm)		Precio (€/ud.)
VS0503035	32	40	32	100	2,49
VS0650951	40	40	32	40	2,70
VS0650953	50	50	32	20	4,05
VS0650955	75	70	32	15	5,23
VS0650957	90	90	42	30	8,54
VS0650959	110	100	42	20	11,77
VS0650961	125	125	51	10	15,65
VS0650963	160	150	57	10	19,49

Accesorios en polipropileno monocapa evacuación insonorizada

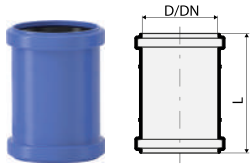

Manguito deslizante

Referencia	D (mm)	DN (mm)	L (mm)		Precio (€/ud.)
VS0650801	32	30	86	60	3,52
VS0650803	40	40	100	30	3,70
VS0650805	50	50	105	30	4,05
VS0650807	75	70	120	20	5,39
VS0650809	90	90	120	20	8,31
VS0650811	110	100	136	20	9,22
VS0650813	125	125	147	20	17,30
VS0650815	160	150	180	1	26,05
VS0650817	200	200	220	1	143,23
VS0650819	250	250	290	1	277,01

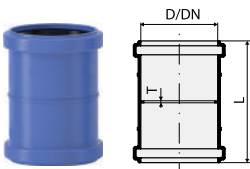

Manguito con tope

Referencia	D (mm)	DN (mm)	L (mm)	T (mm)		Precio (€/ud.)
VS0650851	32	30	80	2	60	3,52
VS0650853	40	40	100	2	30	3,70
VS0650855	50	50	105	2	30	4,05
VS0650857	75	70	120	2	20	5,39
VS0650859	90	90	120	3	20	8,31
VS0650861	110	100	136	3	20	9,22
VS0650863	125	125	147	3	20	17,30
VS0650865	160	150	180	3	1	26,05
VS0650867	200	200	220	4	1	143,23
VS0650869	250	250	290	4	1	277,01

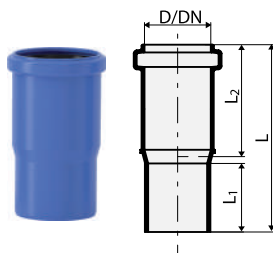

Boca doble profundidad

Referencia	D (mm)	DN (mm)	L1 (mm)	L2 (mm)	L (mm)		Precio (€/ud.)
VS0650759	110	100	61	100	169	20	12,96
VS0650761	125	125	66	108	182	10	17,13

Adaptadores entre distintos sistemas

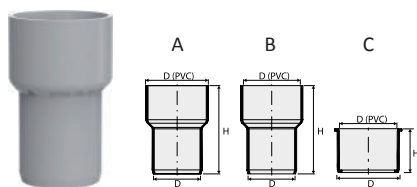

Adaptador en PVC, boca hembra para encolar PVC - macho unión TRIPLUS

Referencia	Mod.	D PVC (mm)	D TRIPLUS (mm)	H (mm)		Precio (€/ud.)
VS0531323	A	43	40	80	100	12,56
VS0531325	A	56	50	88,5	50	15,34
VS0531326	B	60	50	90	50	18,43
VS0531327	C	70	75	53	30	18,43
VS0531333	A	125	110	300	10	22,09
VS0531335	A	140	110	420	5	38,22
VS0531337	A	150	125	420	5	40,55

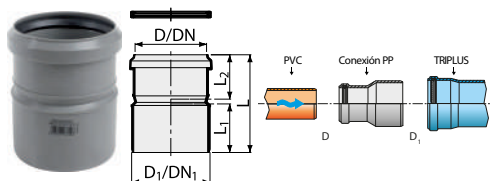

Adaptador en PP, boca hembra con junta unión PVC - macho unión TRIPLUS

Referencia	D/D ₁ (mm)	DN/DN ₁ (mm)	L (mm)	L ₁ (mm)	L ₂ (mm)		Precio (€/ud.)
VS0565001	100/110	100/100	138	69	63	20	10,52

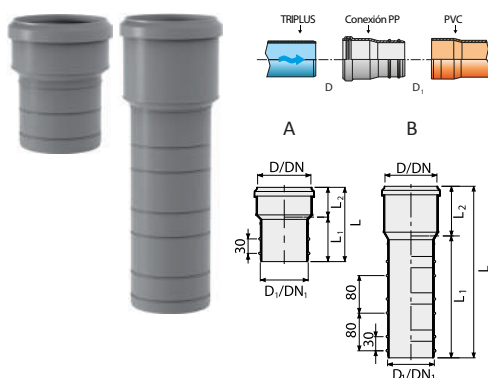

Adaptador en PP, boca hembra con junta unión TRIPLUS - macho con junta unión PVC

Referencia	Mod.	D/D ₁ (mm)	DN/DN ₁ (mm)	L (mm)	L ₁ (mm)	L ₂ (mm)		Precio (€/ud.)
VS0564001	A	110/100	100/100	156	95	60	20	10,83
VS0564003	B	110/100	100/100	367	265	100	15	11,94

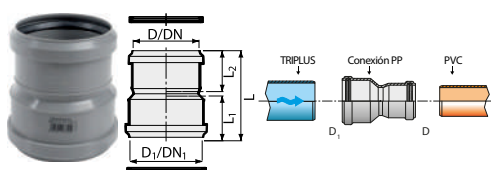

Adaptador en PP, doble boca hembra para unión PVC - TRIPLUS

Referencia	D/D ₁ (mm)	DN/DN ₁ (mm)	L (mm)	L ₁ (mm)	L ₂ (mm)		Precio (€/ud.)
VS0565022	100/110	100/100	134	63	63	20	11,36

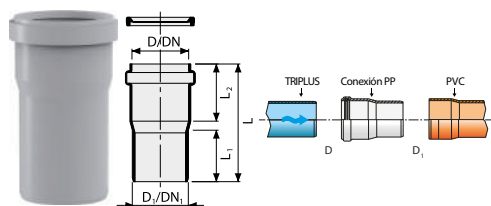

Adaptador en PVC, boca hembra con junta unión TRIPLUS - macho para encolar PVC

Referencia	D/D ₁ (mm)	DN/DN ₁ (mm)	L (mm)	L ₁ (mm)	L ₂ (mm)		Precio (€/ud.)
VS0564121	40/40	40/40	105	50	55	40	5,92
VS0564123	50/50	50/50	105	50	55	30	6,05
VS0564150	50/100	50/100	130	91	40	10	14,07
VS0564075	75/75	70/70	144	87	58	15	12,73
VS0564131	75/80	70/80	154	78	75	15	12,73
VS0564182	75/82	70/80	159	78	80	15	12,73
VS0564175	75/100	70/100	156	77	77	10	14,07
VS0564190	90/100	90/100	143	76	65	10	14,13
VS0564101	110/100	100/100	147	83	57	10	15,07
VS0564251	110/125	100/125	145	83	60	10	14,01

Adaptadores entre distintos sistemas

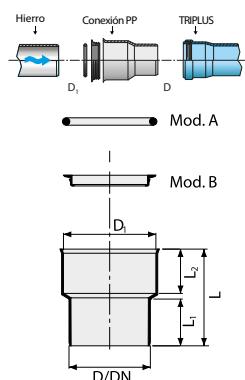

Adaptador en PP, boca hembra con doble sellado (anillo y junta tórica) unión HIERRO – macho unión TRIPLUS

Referencia	D/D ₁ (mm)	DN (mm)	L (mm)	L ₁ (mm)	L ₂ (mm)		Precio (€/ud.)
VS0569001	50/72	50	115	50,9	55	20	5,65
VS0569003	75/92	70	115	50,5	55,6	20	6,88
VS0569005	110/124	100	130	64,6	58,4	20	10,78
VS0569007	125/151	125	145,5	71,9	65	10	34,02

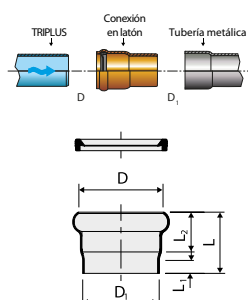

Adaptador de latón, boca hembra con junta unión TRIPLUS - macho unión Tubería metálica

Referencia	D (mm)	D ₁ (mm)	L (mm)	L ₁ (mm)	L ₂ (mm)		Precio (€/ud.)
VS0570001	32	32	61	26	33	40	8,58
VS0570002	40	32	59	28	25	40	8,58
VS0570003	40	40	55	25	25	40	8,58

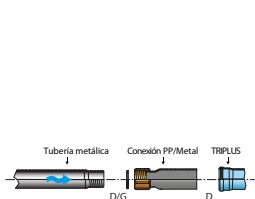
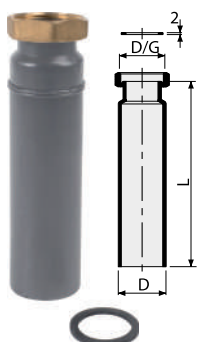

Adaptador prolongador en PP, adaptador rosca hembra unión Tubería metálica o plástica - macho unión TRIPLUS

Referencia	D/G (")	D (mm)	Rosca	L		Precio (€/ud.)
VS0700052	G 1 1/4"	40	Latón	195	20	23,34
VS0700064	G 1 1/2"	40	Latón	195	20	24,78
VS0700252	G 1 1/4"	40	Plástico	195	20	21,24
VS0700264	G 1 1/2"	40	Plástico	195	20	21,68
VS0700267	G 1 1/4"	50	Plástico	195	20	24,78

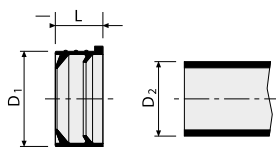

Adaptador elastomérico polivalente para conexión con otros sistemas

Referencia	D ₁ PP (mm)	D ₂ Metal (mm)	L (mm)		Precio (€/ud.)
VS0559001	40	26-28	24	50	2,61
VS0559003	40	30-32	25	50	2,61



Silicona lubricante

Referencia	Descripción		Precio (€/ud.)
VS0900001	Silicona 150 ml.	1	7,86

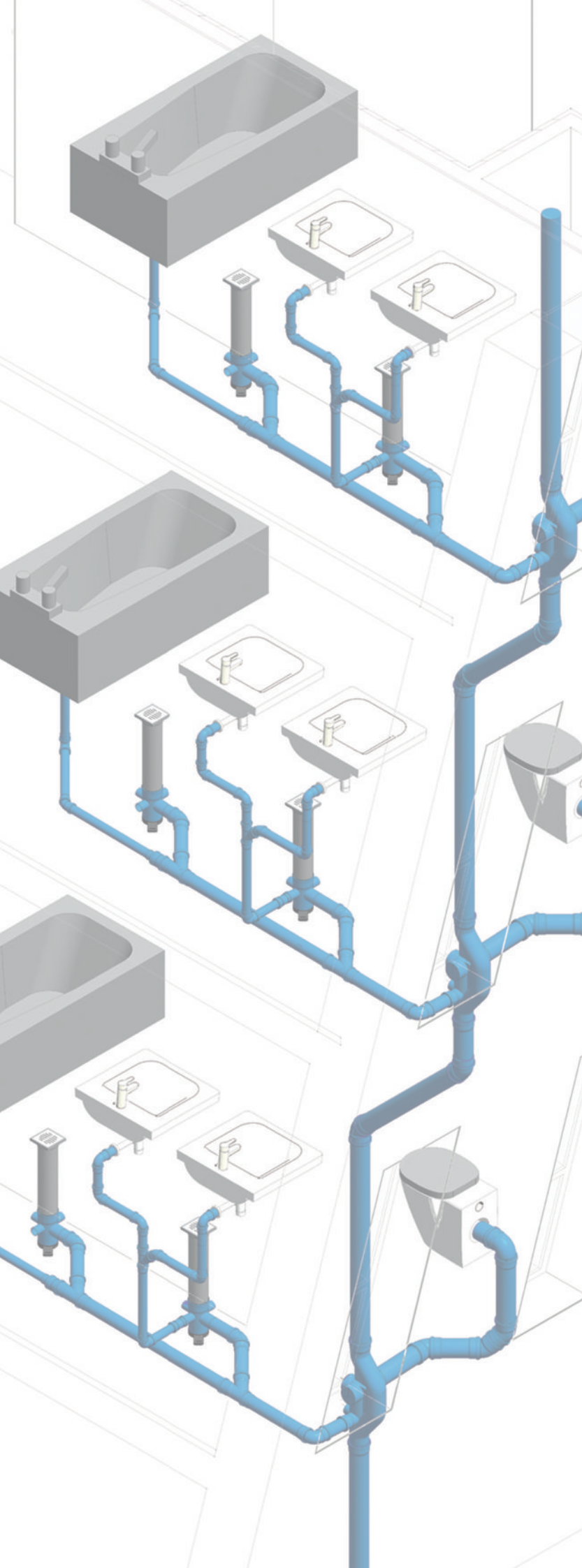

Soluciones en la instalación

Sistema TRIPLUS

Índice

valsir

Curva 87°30' radio largo



Tal y como se detalla en el **Documento Básico HS 5 de Evacuación de Aguas del Código Técnico de la Edificación**, la conexión de las bajantes a los colectores horizontales no deben realizarse mediante simples codos, ni codos reforzados.

Este hecho provoca que dicha conexión sea desarrollada mediante dos codos a 45° o un codo de radio largo.

Con el fin de simplificar la instalación y asegurar la respuesta acústica en la conexión, se ha diseñado la curva a 87°30' de radio largo, desarrollada simulando una conexión mediante dos codos a 45°.

Esta solución da respuesta en una ubicación estratégica, reduciendo la repercusión sonora debido a las descargas y amortiguando debidamente el ruido en un punto sometido a grandes impactos.

Sistema TRIPLUS

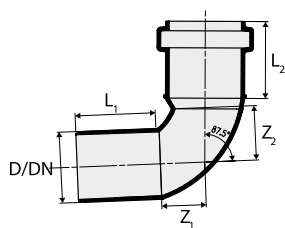

Curva 87° 30' radio largo

Referencia	D (mm)	DN (mm)	Z ₁ (mm)	L ₁ (mm)	Z ₂ (mm)	L ₂ (mm)		Precio (€/ud.)
VS0652901	40	40	25	45	30	43	50	4,00
VS0652902	50	50	31	46	37	45	30	5,20
VS0652903	75	70	48	56	54	52	15	10,56
VS0652904	90	90	57	56	64	56	20	11,92
VS0652905	110	100	69	64	78	59	20	12,37

TRIPLUS Multiconexión



TRIPLUS Multiconexión ha sido concebida para mejorar y simplificar el sistema de instalación, aportando máxima libertad en la implantación de aparatos sanitarios.

- Conexiones directas a diámetros de 32 a 56 mm sin utilización de reducciones.
- Fabricado con material **TRIPLUS** asegurando las características acústicas del sistema.
- Reducción del riesgo de obturación.
- Mejora en el mantenimiento.

Sistema TRIPLUS

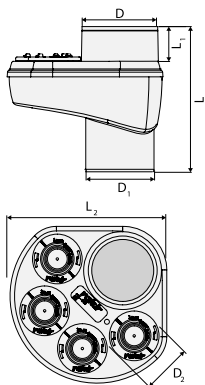
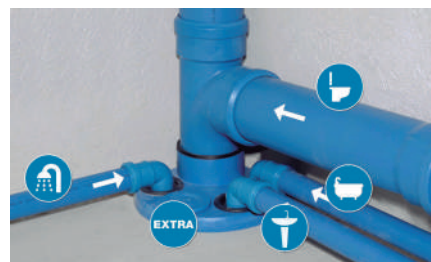

TRIPLUS multiconexión

Referencia	D (mm)	D1 (mm)	D2 (mm)	L (mm)	L1 (mm)	L2 (mm)		Precio (€/ud.)
VS0652001	110/110	110/110	4 x 32-56	230	55	250	2	157,49

TRIPLUS Bote sifónico inspeccionable



El **bote sifónico inspeccionable TRIPLUS** da respuesta a las necesidades encontradas en las instalaciones actuales, permitiendo su colocación suspendido bajo forjado.

- Dotado de soporte orientable para sujeción directa a forjado.
- Gran accesibilidad.
- Sello hidráulico de 75 mm.
- 100% material **TRIPLUS** garantizando el comportamiento acústico del sistema.
- Diámetro de bote 110 mm para conexión directa con tubería insonorizada **TRIPLUS** 110mm.
- Compuesto por tres entradas de $\varnothing 50$ mm y una salida de $\varnothing 75$ mm.

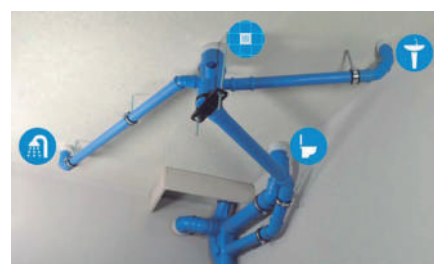

Sistema TRIPLUS

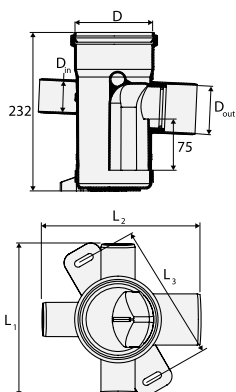

Bote sifónico TRIPLUS inspeccionable

Referencia	D (mm)	Din (mm)	Dout (mm)	L1 (mm)	L2 (mm)	L3 (mm)		Precio (€/ud.)
VS0701741	110	3 x 50	1 x 75	220	230	200	5	65,89

- Bote sifónico Triplus formado por tres entradas de $\varnothing 50$ mm y una salida de 75 mm. Las entradas son ciegas a efectos de ser perforadas en función de las necesidades.
- Incluye sello hidráulico. Altura de sello hidráulico de 75 mm.
- Conexiones directas con bocas hembra mediante junta elástica.
- Se incluye el sistema de soportación inferior que lo hace 360º orientable y ajustable a la altura respecto a forjado.

Ver Complementos en apartado SIFONES y BOTES SIFÓNICOS

Válvula de admisión de aire AIRVAL

Compatibles para instalaciones con gamas de sistemas PP3-TRIPLUS-SILERE-HDPE.



- Testadas y certificadas según norma EN12380, con marcado CE.
- Cumple plenamente con los requisitos de proyecto e instalación de la norma EN 12056.
- Permite la ventilación de tramos mayores a 4 m, evitando un sistema de ventilación indirecta.
- En caso de instalación en terrazas evita la fuga de olores de la bajante.
- Elimina el riesgo de sifonamiento.
- Facilidad de instalación mediante Push-fit, incluso en espacios confinados.

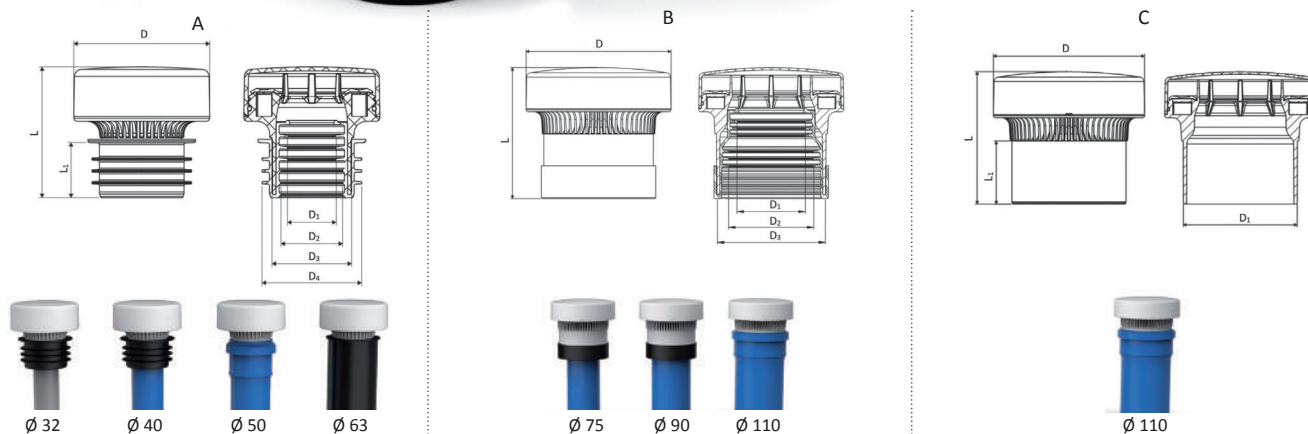

Válvula de admisión de aire AIRVAL

Referencia	Mod.	Q aire máx. (l/s)	D (mm)	D1/D2/D3/D4 (mm)	L/L1 (mm)		Precio (€/ud.)
VS0700404	A	8,0	86	32/40/50/63	83/35	10	41,56
VS0700405	B	34,6	146	75/90/110	132/-	5	89,90
VS0700406	C	39,8	146	110 *	128/61	5	69,58

(*) Con posibilidad para diámetros 75 y 90 mm con conector VS0700553.

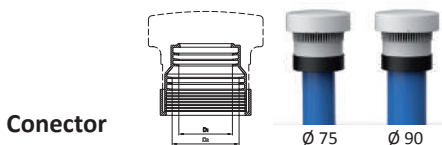

Conector

Referencia	Mod.	D1/D2 (mm)		Precio (€/ud.)
VS0700553	C	75/90	1	20,94

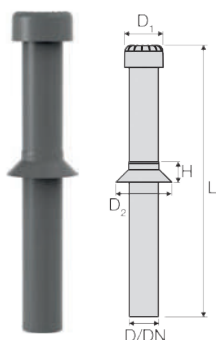

VENTILACIÓN

Terminal del ventilación en PP Gris

Referencia	D (mm)	DN (mm)	D1/D2 (mm)	L (mm)	H (mm)		Precio (€/ud.)
VS0394010	50	50	100/120	705	53	10	63,48
VS0394011	75	75	100/145	705	53	5	70,66
VS0394012	90	90	135/160	705	53	5	75,14
VS0394013	110	100	135/180	705	53	5	79,57

Collarines intumescentes

Compatibles para instalaciones con gamas de sistemas PP3-TRIPLUS-SILERE-HDPE.

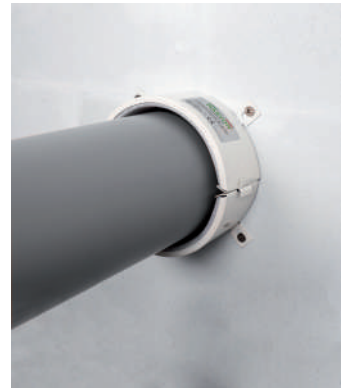
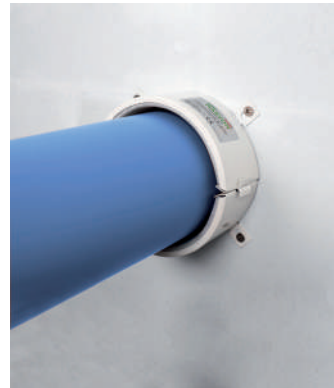

Collarines intumescentes

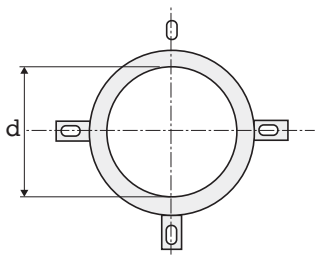

Referencia	D interno (mm)	Nº Fijaciones		Precio (€/ud.)
VS0411051	32	4	1	103,38
VS0411053	40	4	1	109,00
VS0411055	55	4	1	116,82
VS0411057	63	4	1	123,61
VS0411059	75	4	1	125,85
VS0411061	82	4	1	126,82
VS0411063	90	4	1	137,10
VS0411065	110	4	1	142,72
VS0411067	125	4	1	148,34
VS0411069	140	4	1	168,56
VS0411071	160	4	1	185,41
VS0411073	200	6	1	Consultar
VS0411075	250	6	1	Consultar
VS0411077	315	6	1	Consultar

Collarines antideslizamiento

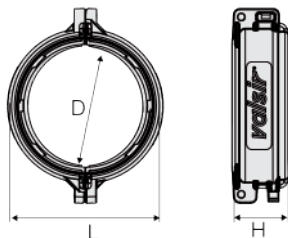

Collarines antideslizamiento

Referencia	D (mm)	L (mm)	H (mm)		Precio (€/ud.)
VS0415004	40	63	42	10	8,10
VS0415005	50	77	42	10	8,90
VS0415007	75	100	46	10	10,61
VS0415009	90	117	49	10	13,00
VS0415011	110	141	52	10	23,47
VS0415012	125	159,2	53	10	42,21
VS0415016	160	197,2	57	10	44,32
VS0415020	200	242,2	74	10	77,47
VS0415025	250	306,2	86,5	10	121,67

Silicona Tecno -S 240



Referencia	Descripción		Precio (€/ud.)
VS0411090	Silicona 310 ml	25	Consultar



Sistema de evacuación con derivación de ventilación

TRIPLUS Derivación de ventilación

La alternativa a la ventilación secundaria y terciaria

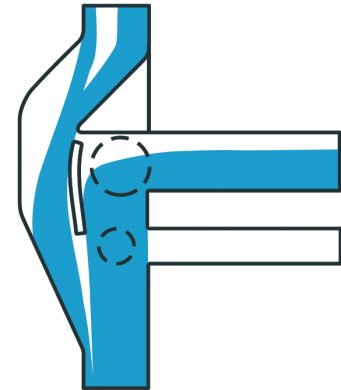

D 110 / 160
(DN 100 / 150)



D 110
(DN 100)

D 75
(DN 70)

En el apartado **Subsistemas de ventilación de las instalaciones** del **Documento Básico HS 5 de Evacuación de Aguas del Código Técnico de la Edificación**, se requiere un subsistema de ventilación secundaria en aquellos edificios de 7 o más plantas, realizando una conexión a la bajante en plantas alternas en los edificios menores a 15 plantas y una conexión en cada planta en edificios de 15 plantas o superiores.

En el mismo Documento Básico se establece que se requiere un subsistema de ventilación terciaria en aquellos edificios que tengan más de 14 plantas o dispongan de ramales de desagüe con una longitud superior a 5 m hasta la bajante.

La utilización de la derivación de ventilación evita la realización de los subsistemas de ventilación secundaria y terciaria, aportando los siguientes beneficios:

- Reducción del espacio necesario en los patinillos donde se albergan las bajantes.
- Aminoración de la velocidad del flujo de descarga.
- Disminución de la rumorosidad gracias a la disminución de la velocidad.
- Aseguramiento de la ventilación.
- Evita la formación de tapones hidráulicos en los puntos de conexión con las ramales.
- Simplificación en la instalación.

Sistema de evacuación con derivación de ventilación

- La derivación de ventilación está prevista para colocación en columnas D110 / 160 (DN 100 / 150).
- La derivación de ventilación se suministra con salida principal abierta a D110 y 160 mm. y el resto de salidas son ciegas para apertura según necesidades en la instalación.

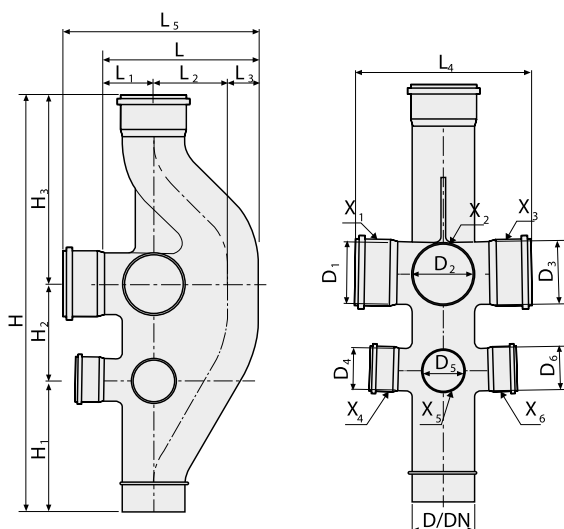

Derivación de ventilación, ref. VS0651X₁X₂X₃X₄X₅X₆*

D (mm)	DN (mm)	D _{1/2/3} (mm)	D _{4/5/6} (mm)	L (mm)	L ₁ (mm)	L ₂ (mm)	L ₃ (mm)	L ₄ (mm)	L ₅ (mm)	H (mm)	H ₁ (mm)	H ₂ (mm)	H ₃ (mm)
110	100	110	75	265	85	130	50	300	345	780	245	170	365

* X=0 si la entrada no dispone de boca soldada / X=1 si la entrada dispone de boca soldada

X₁, X₂, X₃ = diámetro 110 mm

X₄, X₅, X₆ = diámetro 75 mm

Derivación de ventilación, ref. VS0654X₁X₂X₃X₄X₅X₆*

D (mm)	DN (mm)	D _{1/2/3} (mm)	D _{4/5/6} (mm)	L (mm)	L ₁ (mm)	L ₂ (mm)	L ₃ (mm)	L ₄ (mm)	L ₅ (mm)	H (mm)	H ₁ (mm)	H ₂ (mm)	H ₃ (mm)
160	150	110	75	300	100	145	55	340	380	880	310	170	400

* X=0 si la entrada no dispone de boca soldada / X=1 si la entrada dispone de boca soldada

X₁, X₂, X₃ = diámetro 110 mm

X₄, X₅, X₆ = diámetro 75 mm

La derivación de ventilación también se encuentra disponible para la gama de tuberías fonoabsorbentes **SILERE**.

Para más información técnica y/o estudio y presupuesto económico, contactar en el 900 921 957 o bien a través del mail atencionalcliente@italsan.com

Sistema de evacuación con derivación de ventilación

Sistema con ventilación secundaria

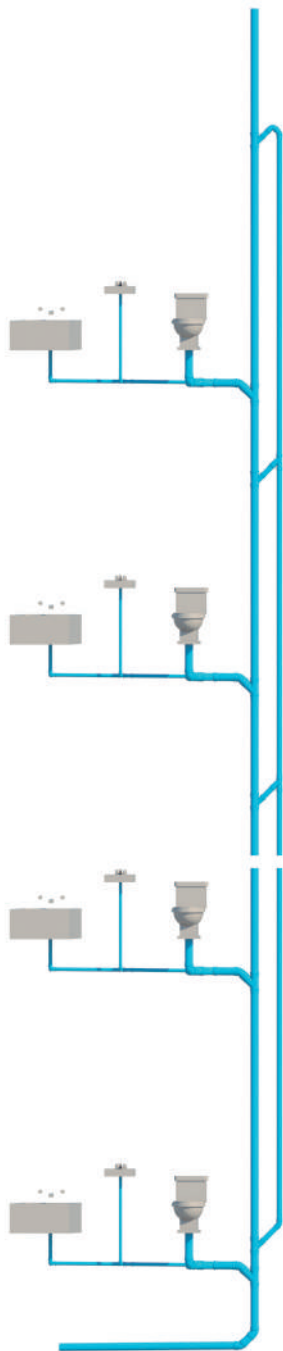

Sistema con ventilación terciaria

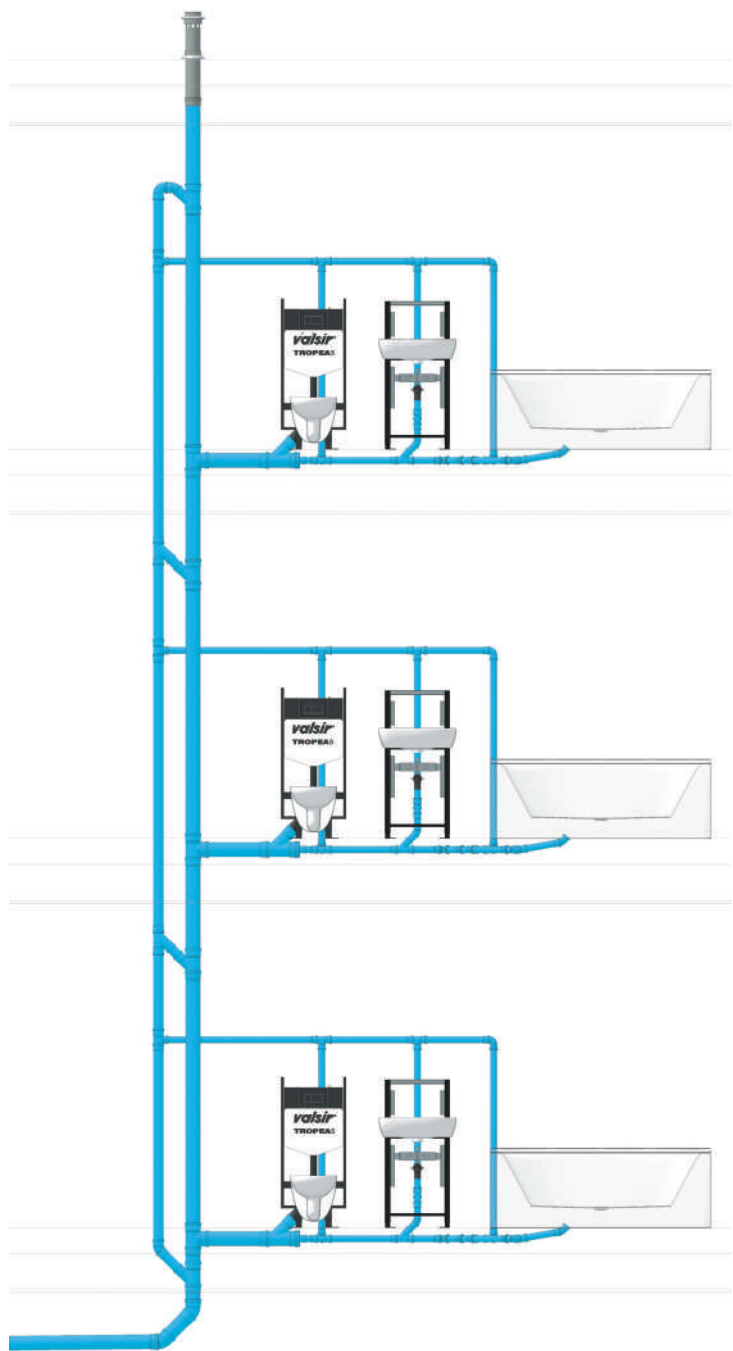

Diámetro 110 mm

Caudal máximo (l/s)	Número máximo de viviendas
5,6	33

Diámetro 160 mm

Caudal máximo (l/s)	Número máximo de viviendas
12,4	161

Sistema TRIPLUS

Sistema de evacuación con derivación de ventilación

Sistema con derivaciones de ventilación

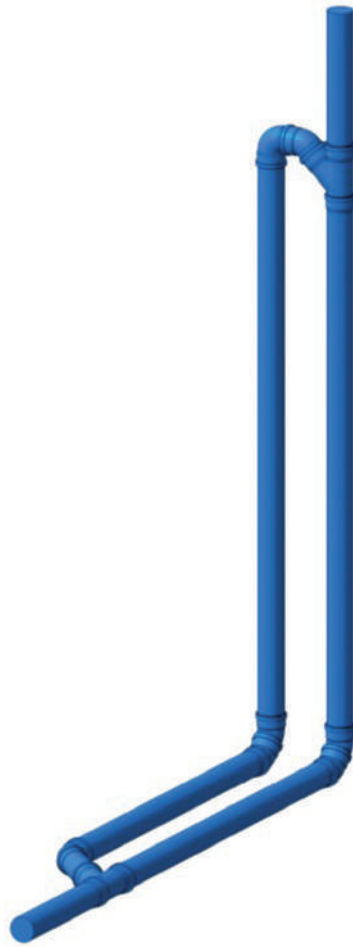
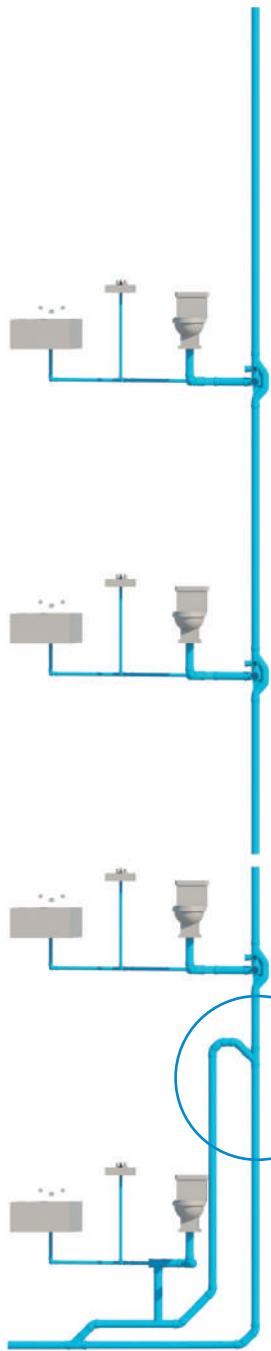

El sistema requiere la colocación de un aliviadero de presión.

* Por vivienda nos referimos a: cocina con fregadero y lavavajillas (max 6 kg) y cuarto de baño con lavabo, bañera, lavadora, bidet e inodoro (con cisterna de 9 l); es decir a un caudal total de 6,7 l/s. El cálculo se ha ejecutado teniendo en cuenta un factor de contemporaneidad K=0,5.

Aspectos a tener en cuenta

Valores superiores a 10 l/s

Están permitidos, pero su uso está vinculado al diseño del sistema y a las elecciones que caracterizan al proyecto (cambios de dirección, longitud de los ramales, número de sanitarios por planta, ventilaciones comunes, etc.). En estos casos se aconseja involucrar en el proyecto al Dpto. Técnico de Italsan.

Valores superiores a 21,1 l/s

Están permitidos, pero su uso está vinculado al diseño del sistema y a las elecciones que caracterizan al proyecto (cambios de dirección, longitud de los ramales, número de sanitarios por planta, ventilaciones comunes, etc.). En estos casos se aconseja involucrar en el proyecto al Dpto. Técnico de Italsan.

Diámetro 110 mm

Caudal máximo (l/s)	Número máximo de viviendas
13	100 *

Diámetro 160 mm

Caudal máximo (l/s)	Número máximo de viviendas
27,4	448 *



PP/PP3 PHONO



Sistema en PP
fonoabsorbente.
La alternativa
al PVC

Tubería PP triple capa fonoabsorbente para evacuación

El sistema PP/PP3 Phono se compone de la tubería en polipropileno triple capa fonoabsorbente y accesorios en polipropileno para la evacuación de aguas residuales y pluviales a baja y alta temperatura.

Capa intermedia

Reforzada con carga mineral. Permite alta resistencia mecánica incluso a baja temperatura.



Campana y espiga de acoplamiento con junta de labio

La campana y espiga de acoplamiento lleva una junta de labio que asegura la estanqueidad hidráulica y el deslizamiento del tubo por efecto de las dilataciones térmicas.



Capa exterior

Polipropileno color gris. Perfecta protección mecánica y resistencia a la abrasión.

Capa interior

Polipropileno color blanco. Excelente resistencia a los agentes químicos.

Características

- Sistema de unión por junta elastomérica monolabial.
- Producto reciclable.
- Declaración libre de halógenos.
- Certificado Fraunhofer P-BA 33/2023e nivel de fonoabsorcencia 11 dB con caudal de descarga 2 l/s según EN14366.

Aplicaciones

- Evacuación agua residuales hasta 95 °C.
- Ventilación primaria, secundaria y terciaria.
- Evacuación aguas pluviales.
- Sistemas gravitatorios industriales.
- Evacuación de condensados de circuitos de climatización.

La instalación

Sistema de unión mediante boca con junta elastomérica monolabial

El sistema PP/PP3 Phono garantiza una instalación rápida y sin el uso de adhesivos, equipos eléctricos o maquinaria especial gracias al sistema de unión con junta labial.



Sistema de unión mediante manguito corredizo

El sistema PP/PP3 Phono dispone del manguito corredizo, el acoplamiento idóneo que permite la unión de dos tubos. Este sistema permite la recuperación de tubos, modificación de instalación y la realización de reparaciones.

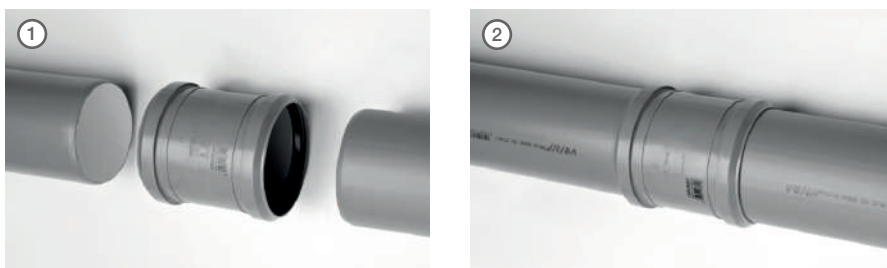

Tubería en PP triple capa fonoabsorbente

Tubo con 1 boca

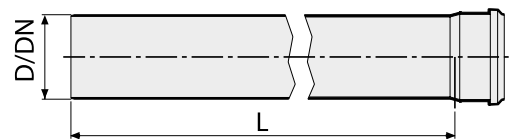

Referencia	D (mm)	DN (mm)	Espesor (mm)	L (mm)		Precio (€/ud.)
VS0501005	32	30	1,8	500	28	2,72
VS0501009	32	30	1,8	1000	24	4,39
VS0501015	32	30	1,8	3000	24	12,23
VS0501025	40	40	1,8	500	20	3,24
VS0501029	40	40	1,8	1000	20	4,17
VS0501033	40	40	1,8	2000	20	6,90
VS0501035	40	40	1,8	3000	20	11,60
VS0501045	50	50	1,8	500	20	2,87
VS0501049	50	50	1,8	1000	30	4,56
VS0501053	50	50	1,8	2000	30	8,74
VS0501055	50	50	1,8	3000	30	12,27
VS0501065	75	70	1,9	500	20	3,88
VS0501069	75	70	1,9	1000	20	6,49
VS0501073	75	70	1,9	2000	20	12,24
VS0501075	75	70	1,9	3000	20	18,60
VS0501145	90	90	2,2	500	24	6,44
VS0501149	90	90	2,2	1000	10	10,87
VS0501153	90	90	2,2	2000	10	22,12
VS0501155	90	90	2,2	3000	10	26,72
VS0501083	110	100	2,7	250	15	4,24
VS0501085	110	100	2,7	500	10	7,46
VS0501089	110	100	2,7	1000	15	12,97
VS0501093	110	100	2,7	2000	15	24,09
VS0501095	110	100	2,7	3000	15	32,34
VS0501105	125	125	3,1	500	6	11,34
VS0501109	125	125	3,1	1000	8	15,68
VS0501113	125	125	3,1	2000	8	36,89
VS0501115	125	125	3,1	3000	8	46,32
VS0501125	160	150	3,9	500	6	19,61
VS0501129	160	150	3,9	1000	6	27,50
VS0501133	160	150	3,9	2000	6	65,18
VS0501135	160	150	3,9	3000	6	74,58
VS0593167 (*)	200	200	6,2	1000	4	77,86
VS0593173 (*)	200	200	6,2	3000	4	169,50
VS0593187 (*)	250	250	7,7	1000	4	128,27
VS0593193 (*)	250	250	7,7	3000	4	283,26

(*) FIREPLUS

Referencias de tubo disponibles en stock, para otros largos de tubo consultar en atencionalcliente@italsan.com o en el 900 921 957

Accesorios en PP fonoabsorbente

Derivación doble

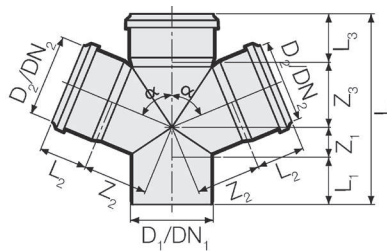

Referencia	D1/D2 (mm)	DN1/ DN2 (mm)	α	Z1 (mm)	Z2 (mm)	Z3 (mm)	L (mm)	L1 (mm)	L2 (mm)	L3 (mm)		Precio (€/ud.)
VS0506001	50/50	50/50	67°30'	20	40	41	172	58	53	53	20	12,78
VS0506005	75/75	70/70	67°30'	28	59	59	206	64	55	55	10	16,67
VS0599085	90/40	90/40	45°	15	85	85	215	58	51,5	57	15	13,17
VS0599087	90/50	90/50	45°	7	90,5	90,5	212,5	58	49,5	57	15	13,17
VS0506010	110/40	100/40	45°	16	104	90,5	239	72	50	60,5	10	18,08
VS0506008	110/50	100/50	45°	16	110	91	227	62	50	58	10	18,08
VS0506019	110/110	100/110	45°	25	136	136	280	61	59	59	5	23,13
VS0506009	110/50	100/50	67°30'	8	78	54	192	68	50	62	10	13,17
VS0506011	110/50	100/50	87°30'	28	60	32	185	60	55	65	10	13,17
VS0506013	110/110	100/100	67°30'	40	86	86	257	66	63	65	5	18,77
VS0506015	110/110	100/100	87°30'	57	84	86	278	70	63	65	5	18,77

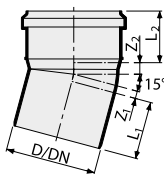

Codo 15°

Referencia	D (mm)	DN (mm)	Z1 (mm)	L1 (mm)	Z2 (mm)	L2 (mm)		Precio (€/ud.)
VS0504001	32	30	5	48	3	45	80	1,51
VS0504013	40	40	6	51	8	53	50	1,16
VS0504025	50	50	1	51	9	50	30	1,36
VS0504049	110	100	14	63	14	60	20	3,24
VS0504061	125	125	15	69	15	72	20	9,77
VS0504073	160	150	35	79	19	73	10	17,47

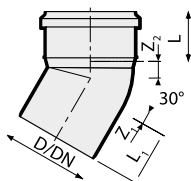

Codo 30°

Referencia	D (mm)	DN (mm)	Z1 (mm)	L1 (mm)	Z2 (mm)	L2 (mm)		Precio (€/ud.)
VS0504003	32	30	7	48	5	45	80	1,51
VS0504015	40	40	9	51	11	53	50	1,16
VS0504027	50	50	10	52	12	51	30	1,36
VS0504051	110	100	20	63	21	65	20	3,68
VS0504063	125	125	24	69	23	73	20	10,63
VS0504075	160	150	25	79	30	82	10	21,62

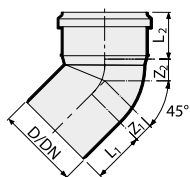

Codo 45°

Referencia	D (mm)	DN (mm)	Z1 (mm)	L1 (mm)	Z2 (mm)	L2 (mm)		Precio (€/ud.)
VS0504005	32	30	5	53	8	45	80	1,50
VS0504017	40	40	9	51	14	53	50	1,03
VS0504029	50	50	12	52	16	51	30	1,19
VS0504041	75	70	20	55	21	54	20	2,05
VS0599045	90	90	22	58	25	57	20	3,96
VS0504053	110	100	30	63	29	61	20	5,17
VS0504065	125	125	33	69	33	72	15	9,77
VS0504077	160	150	42	79	42	85	10	16,82
VS0593485 *	200	200	63	180	86	170	1	107,08
VS0593495 *	250	250	57	210	88	203	1	254,25

(*) FIREPLUS

Accesorios en PP fonoabsorbente

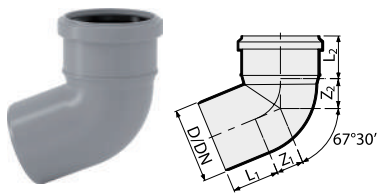

Codo 67° 30'

Referencia	D (mm)	DN (mm)	Z1 (mm)	L1 (mm)	Z2 (mm)	L2 (mm)		Precio (€/ud.)
VS0504007	32	30	9	53	20	45	60	1,29
VS0504019	40	40	16	51	20	53	50	1,15
VS0504031	50	50	20	51	23	51	30	1,31
VS0504055	110	100	44	63	44	65	20	4,00
VS0504067	125	125	49	69	50	72	15	11,12

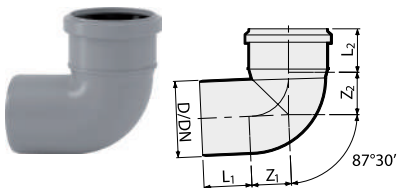

Codo 87° 30'

Referencia	D (mm)	DN (mm)	Z1 (mm)	L1 (mm)	Z2 (mm)	L2 (mm)		Precio (€/ud.)
VS0504011	32	30	12	53	26	45	60	1,50
VS0504023	40	40	23	51	26	53	50	1,10
VS0504035	50	50	30	52	31	57	30	1,28
VS0504047	75	70	40	55	43	55	20	2,13
VS0599051	90	90	48	58	51	57	20	4,76
VS0504059	110	100	57	63	61	66	20	5,17
VS0504071	125	125	71	69	70	72	10	10,29
VS0504083	160	150	87	79	89	85	10	20,55
VS0650489 *	200	200	148	180	172	170	1	178,08
VS0650499 *	250	250	122	210	163	203	1	303,39

(*) TRIPLUS

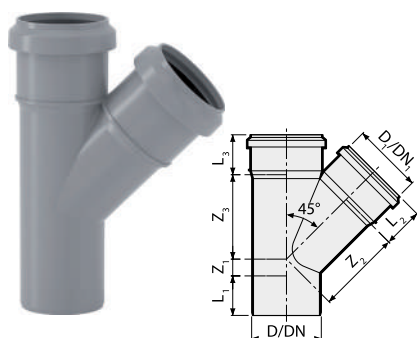

Derivación 45°

Referencia	D/D1 (mm)	DN/DN1 (mm)	Z1 (mm)	Z2 (mm)	Z3 (mm)	L1 (mm)	L2 (mm)	L3 (mm)		Precio (€/ud.)
VS0508001	32/32	30/30	10	49	49	51	60	60	40	3,07
VS0508007	40/40	40/40	10	49	49	50	60	60	20	2,22
VS0508013	50/50	50/50	12	61	61	53	55	54	20	3,19
VS0508019	75/75	70/70	18	91	91	57	54	54	20	4,00
VS0599061	90/90	90/90	22	110	110	58	57	57	20	5,80
VS0508025	110/110	100/100	25	134	134	64	63	63	15	10,16
VS0508031	125/125	125/125	28	152	152	69	68	69	10	29,08
VS0508037	160/160	150/150	36	194	194	94	87	86	1	65,18
VS0593669 *	200	200	46	145	273	135	273	135	1	205,50
VS0593685 *	250	250	21	170	336	160	336	160	1	426,64

(*) FIREPLUS, Piezas manipuladas

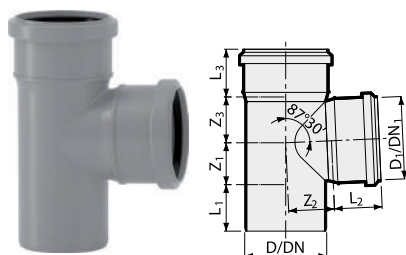

Derivación 87° 30'

Referencia	D/D1 (mm)	DN/DN1 (mm)	Z1 (mm)	Z2 (mm)	Z3 (mm)	L1 (mm)	L2 (mm)	L3 (mm)		Precio (€/ud.)
VS0508005	32/32	30/30	23	18	25	37	50	50	40	3,07
VS0508011	40/40	40/40	23	25	25	64	60	59	20	2,22
VS0508017	50/50	50/50	28	32	30	54	49	49	20	3,19
VS0508023	75/75	70/70	40	25	43	59	54	55	20	4,00
VS0599065	90/90	90/90	48	52	52	58	57	57	20	5,80
VS0508029	110/110	100/100	57	60	62	62	65	65	20	6,88
VS0508035	125/125	125/125	65	69	70	68	68	68	10	27,04
VS0508041	160/160	150/150	83	150	89	160	87	87	4	60,20
VS0650671 *	200	200	100	145	137	135	137	135	1	280,77
VS0650687 *	250	250	130	170	165	160	165	160	1	467,32

(*) TRIPLUS, Piezas manipuladas

Accesorios en PP fonoabsorbente

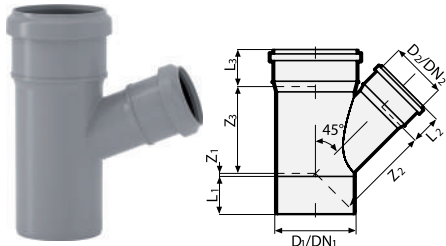

Derivación reducida 45°

Referencia	D/D ₁ (mm)	DN/DN ₁ (mm)	Z ₁ (mm)	Z ₂ (mm)	Z ₃ (mm)	L ₁ (mm)	L ₂ (mm)	L ₃ (mm)		Precio (€/ud.)
VS0510001	40/32	40/30	10	45	49	41	52	46	40	3,33
VS0510007	50/40	50/40	5	56	54	53	57	54	20	3,29
VS0510013	75/40	70/40	-7	73	67	56	51	59	25	3,34
VS0510019	75/50	70/50	-1	80	74	58	54	54	25	3,95
VS0599073	90/50	90/50	-7	90,5	82	58	49,5	57	25	4,12
VS0510025	110/40	100/40	-24	101	84	55	51	63	15	4,39
VS0510031	110/50	100/50	-17	96	91	47	49	63	20	4,93
VS0510037	110/75	100/75	1	120	109	63	55	65	20	6,18
VS0599089	110/90	100/90	9,3	124,4	118,5	61,7	57,6	60,5	15	12,24
VS0510043	125/50	125/50	-24	114	99	80	54	72	10	19,59
VS0510049	125/110	125/100	18	137	141	89	69	69	8	19,66
VS0510061	160/110	150/100	1	171	159	99	70	82	5	60,72
VS0510067	160/125	150/125	12	180	169	105	79	85	5	65,99

Derivación reducida 87° 30'

Referencia	D ₁ /D ₂ (mm)	DN ₁ /DN ₂ (mm)	Z ₁ (mm)	Z ₂ (mm)	Z ₃ (mm)	L ₁ (mm)	L ₂ (mm)	L ₃ (mm)		Precio (€/ud.)
VS0510005	40/32	40/30	23	23	25	33	51	51	40	3,33
VS0510011	50/40	50/40	23	30	25	54	50	50	25	3,10
VS0510017	75/40	70/40	22	45	26	52	50	54	25	4,36
VS0510023	75/50	70/50	27	25	31	58	50	54	25	3,79
VS0599075	90/40	90/40	23	50,5	27	58	51	57	20	4,08
VS0599077	90/50	90/50	28	50	32	58	49,5	57	20	4,18
VS0510029	110/40	100/40	23	60	27	60	51	65	20	4,04
VS0510035	110/50	100/50	28	62	32	60	50	64	20	5,37
VS0510041	110/75	100/75	40	61	45	61	55	65	15	6,39
VS0599091	110/90	100/90	40,7	62,4	51,5	62,3	57,5	60,5	10	18,39
VS0510053	125/110	125/100	58	70	63	83	63	68	8	22,28
VS0510065	160/110	150/110	58	86	64	99	72	84	5	61,01

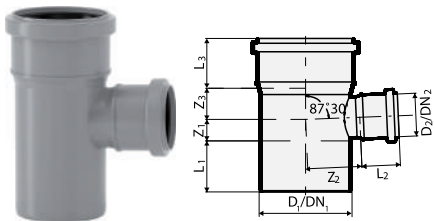

Inspección con tapón roscado

Referencia	D (mm)	DN (mm)	Z ₁ (mm)	Z ₃ (mm)	L ₁ (mm)	L ₂ (mm)	K (mm)	Dc (mm)	H (mm)		Precio (€/ud.)
VS0516003	50	50	28	30	82	54	75	90	83	20	5,56
VS0516005	75	70	40	43	58	54	66	90	77	20	7,08
VS0599151	90	90	49	52	58	57	100	118	85	20	8,47
VS0516009	125	125	58	63	67	69	120	149	126	10	27,35
VS0516011	160	150	58	64	93	83	120	149	126	5	49,22

Inspección lineal con tapón

Referencia	D (mm)	DN (mm)	Z ₁ (mm)	Z ₃ (mm)	L ₁ (mm)	L ₂ (mm)	K (mm)	Dc (mm)	H (mm)		Precio (€/ud.)
VS0593901 (*)	50	50	28	30	82	54	75	90	83	20	11,65
VS0516007	110	100	57	62	61	67	105	118	100	15	8,53
VS0593909 (*)	125	125	58	63	67	69	120	149	126	10	43,47
VS0593911 (*)	160	150	58	64	93	83	120	149	126	5	66,91

(*) FIREPLUS

Reducción

Referencia	D/D ₂ (mm)	DN/DN ₂ (mm)	L (mm)	L ₁ (mm)		Precio (€/ud.)
VS0599135	90/75	90/70	76	61	20	2,70
VS0599137	110/90	100/90	81,5	65	20	3,87
VS0514015	125/110	125/110	86	68	30	11,91

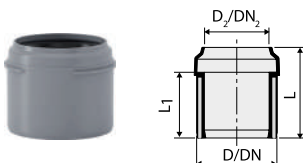
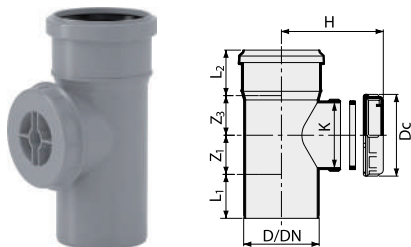

Accesorios en PP fonoabsorbente

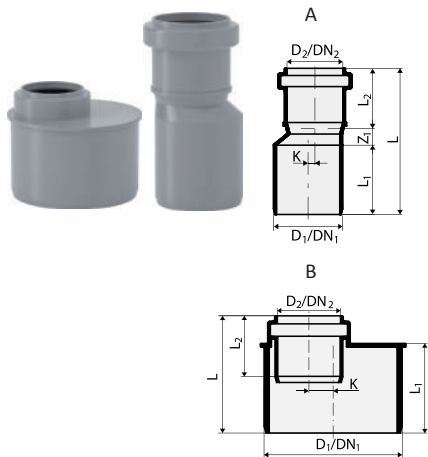

Reducción excéntrica

Referencia	Mod.	D/D2 (mm)	DN/DN2 (mm)	K (mm)	Z1 (mm)	L (mm)	L1 (mm)	L2 (mm)		Precio (€/ud.)
VS0514001	A	40/32	40/30	4	12	998	41	44	50	1,91
VS0514003	A	50/40	50/40	5	13	125	51	58	50	1,58
VS0514005	B	75/40	70/40	11	54	75	60	58	30	2,51
VS0514007	B	75/50	70/50	5	50	75	59	58	30	2,20
VS0599131	B	90/40	90/40	7	-	77	61	46,5	20	2,91
VS0599133	B	90/50	90/50	11	-	76	61	45,5	20	2,70
VS0593717 (*)	B	110/40	100/40	21,5	-	83	66	47	20	7,12
VS0514008	B	110/40	100/40	21,5	-	83	66	47	20	3,39
VS0514009	B	110/50	100/50	9	50	82	66	54	20	3,39
VS0514011	B	110/75	100/70	16	55	82	66	56	20	3,39
VS0514043	A	125/110	125/100	7	12	138	64	62	20	11,13
VS0514017	B	160/110	150/100	10	80	173	97	81	20	15,14
VS0514019	B	160/125	150/125	4	80	160	92	82	20	15,14
VS0593739 (*)	A	200/160	200/150	18	45	93	77	215	1	163,69
VS0593747 (*)	A	250/200	250/200	23	51	124	135	310	1	244,60

(*) FIREPLUS, Piezas manipuladas

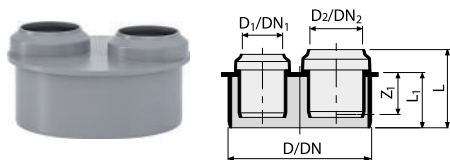

Reductor corto doble

Referencia	D/D1/D2 (mm)	DN/DN1/DN2 (mm)	Z1 (mm)	L (mm)	L1 (mm)		Precio (€/ud.)
VS0525001	110/40/32	100/40/30	30	60	42	15	30,21
VS0525003	110/40/40	100/40/40	30	60	42	15	26,58
VS0525005	125/40/50	125/40/50	30	67	57	10	34,34

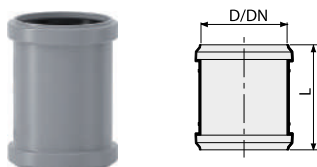

Manguito deslizante

Referencia	D (mm)	DN (mm)	L (mm)		Precio (€/ud.)
VS0526000	32	30	85	60	2,00
VS0526001	40	40	108	30	1,63
VS0526003	50	50	108	30	1,80
VS0526005	75	70	120	20	3,04
VS0599101	90	90	120	20	4,32
VS0526007	110	100	136	20	4,87
VS0526009	125	125	147	20	12,19
VS0526011	160	150	204	10	21,41
VS0593817 (*)	200	200	220	1	132,35
VS0593819 (*)	250	250	290	1	256,01

(*) FIREPLUS

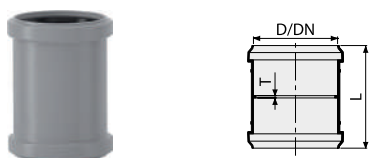

Manguito con tope

Referencia	D (mm)	DN (mm)	L (mm)	T (mm)		Precio (€/ud.)
VS0528000	32	30	85	2	60	2,00
VS0528001	40	40	108	2	30	1,63
VS0528003	50	50	108	2	30	1,80
VS0528005	75	70	120	2	20	2,89
VS0599111	90	90	120	2	20	4,32
VS0528007	110	100	136	3	20	4,67
VS0528009	125	125	147	3	20	12,19
VS0528011	160	150	210	28	10	20,46
VS0593867 *	200	200	200	200	1	132,35
VS0593869 *	250	250	250	250	1	256,01

(*) FIREPLUS

Accesorios en PP fonoabsorbente

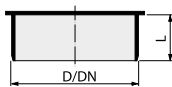

Tapón

Referencia	D (mm)	DN (mm)	L (mm)		Precio (€/ud.)
VS0503035	32	40	32	100	2,49
VS0524001	40	40	32	40	0,89
VS0524003	50	50	32	20	1,10
VS0524005	75	70	32	15	1,41
VS0599141	90	90	35	30	2,55
VS0524007	110	100	40	20	2,20
VS0524009	125	125	47	10	5,16
VS0524011	160	150	48	10	9,93

Adaptadores entre distintos sistemas

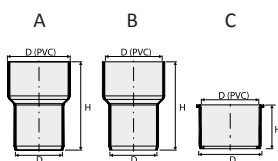

Adaptador en PVC, boca hembra para encolar PVC - macho unión PP/PP3 Phono

Referencia	Mod.	D PVC (mm)	D PP/PP3 Phono (mm)	H (mm)		Precio (€/ud.)
VS0531323	A	43	40	80	100	12,56
VS0531325	A	56	50	88,5	50	15,34
VS0531326	B	60	50	90	50	18,43
VS0531327	C	70	75	53	30	18,43
VS0531333	A	125	110	300	10	22,09
VS0531335	A	140	110	420	5	38,22
VS0531337	A	150	125	420	5	40,55

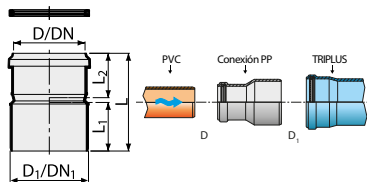

Adaptador en PP, boca hembra con junta unión PVC - macho unión PP/PP3 Phono

Referencia	D/D1 (mm)	DN/DN1 (mm)	L (mm)	L1 (mm)	L2 (mm)		Precio (€/ud.)
VS0565001	100/110	100/100	138	69	63	20	10,52

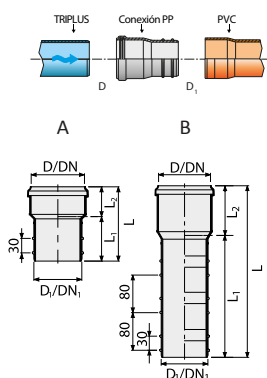

Adaptador en PP, boca hembra con junta unión PP/PP3 Phono - macho con junta unión PVC

Referencia	Mod.	D/D1 (mm)	DN/DN1 (mm)	L (mm)	L1 (mm)	L2 (mm)		Precio (€/ud.)
VS0564001	A	110/100	100/100	156	95	60	20	10,83
VS0564003	B	110/100	100/100	367	265	100	15	11,94

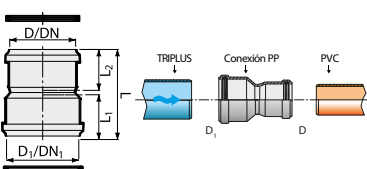

Adaptador en PP, doble boca hembra para unión PVC - PP/PP3 Phono

Referencia	D/D1 (mm)	DN/DN1 (mm)	L (mm)	L1 (mm)	L2 (mm)		Precio (€/ud.)
VS0565022	100/110	100/100	134	63	63	20	11,36

Adaptadores entre distintos sistemas

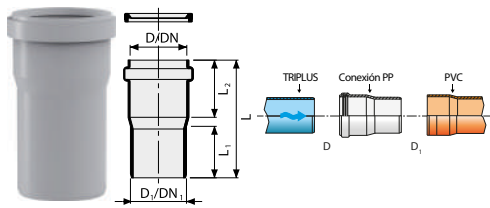

Adaptador en PP, boca hembra con junta unión PP/PP3 Phono - macho para encolar PVC

Referencia	D/D ₁ (mm)	DN/DN ₁ (mm)	L (mm)	L ₁ (mm)	L ₂ (mm)		Precio (€/ud.)
VS0564121	40/40	40/40	105	50	55	40	5,92
VS0564123	50/50	50/50	105	50	55	30	6,05
VS0564150	50/100	50/100	130	91	40	10	14,07
VS0564075	75/75	70/70	144	87	58	15	12,73
VS0564131	75/80	70/80	154	78	75	15	12,73
VS0564182	75/82	70/80	159	78	80	15	12,73
VS0564175	75/100	70/100	156	77	77	10	14,07
VS0564190	90/100	90/100	143	76	65	10	14,13
VS0564101	110/100	100/100	147	83	57	10	15,07
VS0564251	110/125	100/125	145	83	60	10	14,01

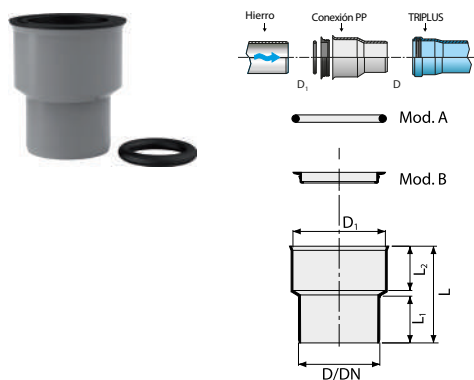

Adaptador en PP, boca hembra con doble sellado (anillo y junta tórica) unión HIERRO - macho unión PP/PP3 Phono

Referencia	D/D ₁ (mm)	DN (mm)	L (mm)	L ₁ (mm)	L ₂ (mm)		Precio (€/ud.)
VS0569001	50/72	50	115	50,9	55	20	5,65
VS0569003	75/92	70	115	50,5	55,6	20	6,88
VS0569005	110/124	100	130	64,6	58,4	20	10,78
VS0569007	125/151	125	145,5	71,9	65	10	34,02

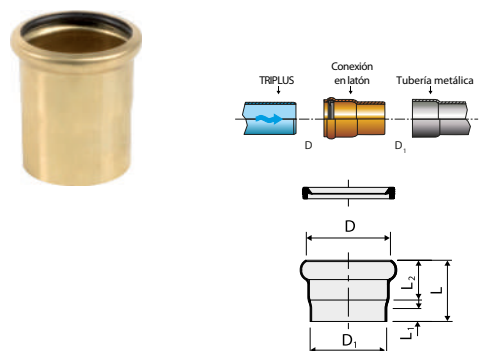

Adaptador de latón, boca hembra con junta unión PP/PP3 Phono - macho unión Tubería metálica

Referencia	D (mm)	D ₁ (mm)	L (mm)	L ₁ (mm)	L ₂ (mm)		Precio (€/ud.)
VS0570001	32	32	61	26	33	40	8,58
VS0570002	40	32	59	28	25	40	8,58
VS0570003	40	40	55	25	25	40	8,58

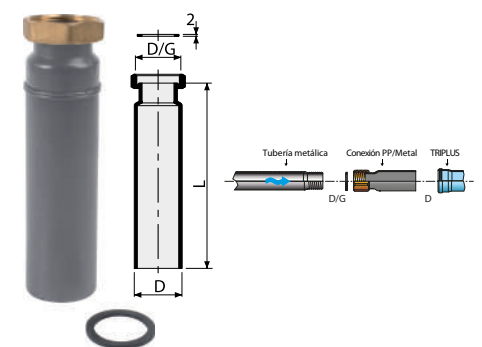

Adaptador prolongador en PP, adaptador rosca hembra unión Tubería metálica o plástica - macho unión PP/PP3 Phono

Referencia	D/G (")	D (mm)	Rosca	L		Precio (€/ud.)
VS0700052	G 1 1/4"	40	Latón	195	20	23,34
VS0700064	G 1 1/2"	40	Latón	195	20	24,78
VS0700252	G 1 1/4"	40	Plástico	195	20	21,24
VS0700264	G 1 1/2"	40	Plástico	195	20	21,68
VS0700267	G 1 1/4"	50	Plástico	195	20	24,78

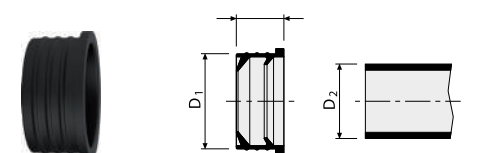

Adaptador elastomérico polivalente para conexión con otros sistemas

Referencia	D ₁ PP (mm)	D ₂ Metal (mm)	L (mm)		Precio (€/ud.)
VS0559001	40	26-28	24	50	2,61
VS0559003	40	30-32	25	50	2,61



PP3 FIREPLUS



Sistema en PP
fonoabsorbente.
Reacción al fuego
B-s1,d0

Tubería PP triple capa fonoabsorbente para evacuación con clasificación B-s1,d0 según EN 13501

El Sistema FIREPLUS se compone de tubería en polipropileno triple capa fonoabsorbente y accesorios en polipropileno para la evacuación de aguas residuales y pluviales a baja y alta temperatura, fabricado según norma UNE-EN 1451-1 y con certificado de clasificación B-s1,d0 de reacción al fuego según UNE-EN 13501.

Capa intermedia

Reforzada con carga mineral. Permite alta resistencia mecánica incluso a baja temperatura.



Campana y espiga de acoplamiento con junta de labio

La campana y espiga de acoplamiento lleva una junta de labio que asegura la estanqueidad hidráulica y el deslizamiento del tubo por efecto de las dilataciones térmicas.



Capa exterior

Polipropileno color gris. Perfecta protección mecánica y resistencia a la abrasión.

Capa interior

Polipropileno color blanco. Excelente resistencia a los agentes químicos.

Con retardante al fuego

Producto reciclable



Características

- Sistema de unión por junta elastomérica monolabial.
- Producto reciclable.
- Declaración libre de halógenos.
- Certificado Fraunhofer P-BA 81/2024e con nivel de fonoabsorcencia <10 dB con caudal de descarga 2 l/s según EN 14366.
- Certificado reacción al fuego EN 13501-1.

Índice

Aplicaciones

- Evacuación agua residuales hasta 95 °C.
- Ventilación primaria, secundaria y terciaria.
- Evacuación aguas pluviales.
- Sistemas gravitatorios industriales.

La instalación

Sistema de unión mediante boca con junta elastomérica monolabial

El Sistema FIREPLUS garantiza una instalación rápida y sin el uso de adhesivos, equipos eléctricos o maquinaria especial gracias al sistema de unión con junta labial.



Sistema de unión mediante manguito corredizo

El Sistema FIREPLUS dispone del manguito corredizo, el acoplamiento idóneo que permite la unión de dos tubos. Este sistema permite la recuperación de tubos, modificación de instalación y la realización de reparaciones.

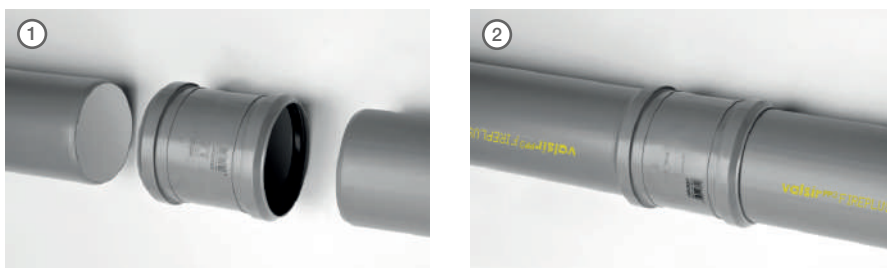

Tubería FIREPLUS en PP triple capa fonoabsorbente

Tubo con 1 boca

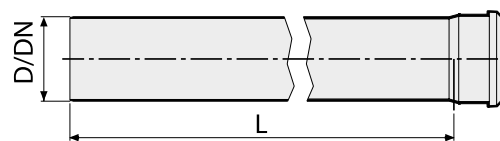
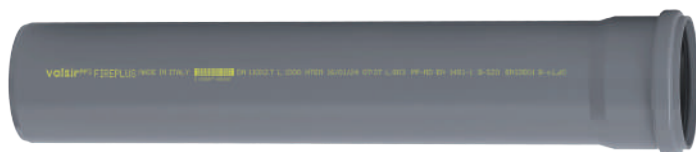

Referencia	D (mm)	DN (mm)	Espesor (mm)	L (mm)		Precio (€/ud.)
VS0593025	40	40	1,8	500	54	3,76
VS0593027	40	40	1,8	1000	20	5,88
VS0593033	40	40	1,8	3000	20	16,34
VS0593047	50	50	1,8	1000	30	5,90
VS0593053	50	50	1,8	3000	30	17,59
VS0593067	75	70	1,9	1000	20	9,74
VS0593075	75	70	1,9	3000	20	27,23
VS0593087	90	90	2,2	1000	10	15,29
VS0593093	90	90	2,2	3000	10	39,05
VS0593105	110	100	2,7	500	10	10,36
VS0593107	110	100	2,7	1000	15	16,20
VS0593113	110	100	2,7	3000	15	44,41
VS0593127	125	125	3,1	1000	8	23,54
VS0593133	125	125	3,1	3000	8	60,72
VS0593147	160	150	3,9	1000	6	35,25
VS0593153	160	150	3,9	3000	6	93,10
VS0593167	200	200	6,2	1000	4	77,86
VS0593173	200	200	6,2	3000	4	169,50
VS0593187	250	250	7,7	1000	4	128,27
VS0593193	250	250	7,7	3000	4	283,26

Marcaje de la nueva tubería FIREPLUS y de sus accesorios



Accesorios FIREPLUS en PP fonoabsorbente

Codo 45°

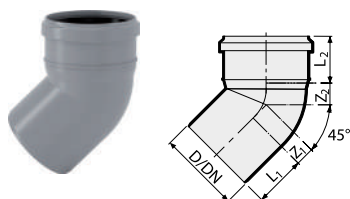

Referencia	D (mm)	DN (mm)	Z1 (mm)	L1 (mm)	Z2 (mm)	L2 (mm)		Precio (€/ud.)
VS0593415	40	40	9	51	14	53	50	2,35
VS0593425	50	50	12	52	16	51	30	2,86
VS0593435	75	70	20	55	21	54	20	5,13
VS0593445	90	90	22	58	25	57	20	6,97
VS0593455	110	100	30	63	29	61	20	7,30
VS0593465	125	125	33	69	33	72	15	14,61
VS0593475	160	150	42	79	42	85	10	22,83
VS0593485	200	200	42	115	57	114	1	107,08
VS0593495	250	250	52	155	86	138	1	254,25

Codo 87° 30'

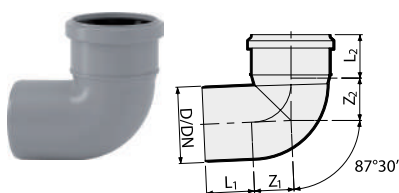

Referencia	D (mm)	DN (mm)	Z1 (mm)	L1 (mm)	Z2 (mm)	L2 (mm)		Precio (€/ud.)
VS0593419	40	40	23	51	26	53	50	2,51
VS0593429	50	50	30	52	31	57	30	3,17
VS0593439	75	70	40	55	43	55	20	6,69
VS0593449	90	90	48	58	51	57	20	7,42
VS0593459	110	100	57	63	61	66	20	7,80
VS0593469	125	125	71	69	70	72	10	21,41
VS0593479	160	150	87	79	89	85	10	35,40

Resto de diámetros disponibles bajo pedido.

Derivación 45°

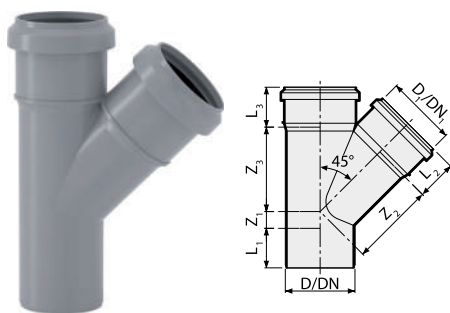

Referencia	D/D1 (mm)	DN/DN1 (mm)	Z1 (mm)	Z2 (mm)	Z3 (mm)	L1 (mm)	L2 (mm)	L3 (mm)		Precio (€/ud.)
VS0593507	40/40	40/40	10	49	49	50	60	60	20	5,45
VS0593513	50/50	50/50	12	61	61	53	55	54	20	6,53
VS0593519	75/75	70/70	18	91	91	57	54	54	20	9,04
VS0593525	90/90	90/90	22	110	110	58	57	57	20	13,60
VS0593531	110/110	100/100	25	134	134	64	63	63	15	15,22
VS0593537	125/125	125/125	28	152	152	69	68	69	10	52,78
VS0593543	160/160	150/150	36	194	194	94	87	86	1	82,28
VS0593669 *	200/200	200/200	42	195	275	133	275	133	1	205,50
VS0593685 *	250/250	250/250	52	180	333	163	333	162	1	426,64

* Piezas manipuladas.

Derivación 87° 30'

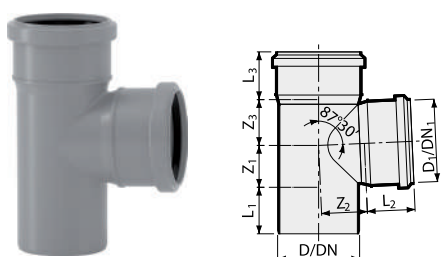

Referencia	D/D1 (mm)	DN/DN1 (mm)	Z1 (mm)	Z2 (mm)	Z3 (mm)	L1 (mm)	L2 (mm)	L3 (mm)		Precio (€/ud.)
VS0593511	40/40	40/40	23	25	25	64	60	59	20	5,45
VS0593517	50/50	50/50	28	32	30	54	49	49	20	6,53
VS0593523	75/75	70/70	40	25	43	59	54	55	20	9,04
VS0593529	90/90	90/90	48	52	52	58	57	57	20	13,60
VS0593535	110/110	100/100	57	60	62	62	65	65	20	15,22
VS0593541	125/125	125/125	65	69	70	68	68	68	10	52,78
VS0593547	160/160	150/150	83	150	89	160	87	87	4	82,28

Resto de diámetros disponibles bajo pedido.

Accesorios FIREPLUS en PP fonoabsorbente

Derivación reducida 45°

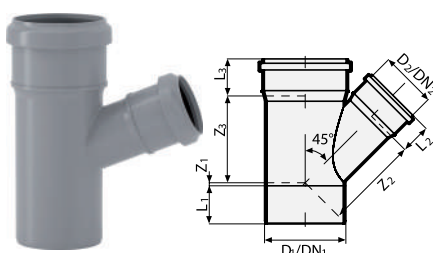

Referencia	D/D1 (mm)	DN/DN1 (mm)	Z1 (mm)	Z2 (mm)	Z3 (mm)	L1 (mm)	L2 (mm)	L3 (mm)		Precio (€/ud.)
VS0593587	110/40	100/40	-24	101	84	55	51	63	20	15,22
VS0593593	110/50	100/50	-17	98	91	47	49	63	20	15,22
VS0593599	110/75	110/70	1	120	109	63	55	65	15	15,22
VS0593611	125/110	125/100	18	137	141	89	69	69	8	34,75
VS0593617	160/110	150/100	1	17	159	99	70	82	5	54,79

Resto de diámetros disponibles bajo pedido.

Derivación reducida 87° 30'

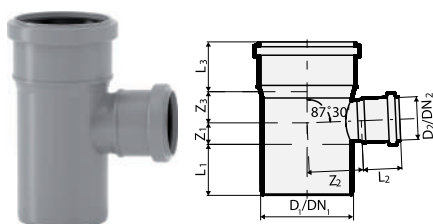

Referencia	D1/D2 (mm)	DN1/DN2 (mm)	Z1 (mm)	Z2 (mm)	Z3 (mm)	L1 (mm)	L2 (mm)	L3 (mm)		Precio (€/ud.)
VS0593591	110/40	100/40	23	60	27	60	51	65	20	15,22
VS0593597	110/50	100/50	28	62	32	60	50	64	20	15,22
VS0593615	125/110	125/100	58	70	63	83	63	68	8	34,79

Resto de diámetros disponibles bajo pedido.

Derivación doble 45°

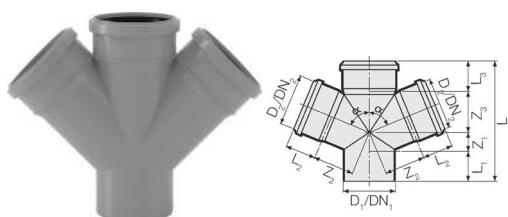

Referencia	D1/D2/D3 (mm)	DN1/DN2/DN3 (mm)	Z1 (mm)	Z2/Z3/Z4 (mm)	L (mm)	L1 (mm)	L2/L3/L4 (mm)		Precio (€/ud.)
VS0593655	110/110/110	100/100/100	25	136	280	61	59	15	30,44
VS0593658	125/125/125	125/125/125	-	152	319	72	64	1	148,08

Derivación doble 87° 30'

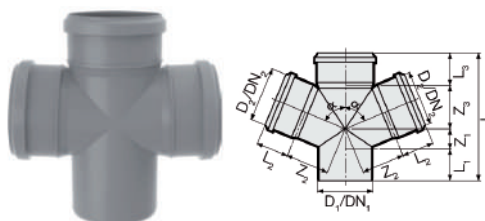

Referencia	D1/D2/D3 (mm)	DN1/DN2/DN3 (mm)	Z1 (mm)	Z2/Z4 (mm)	Z3 (mm)	L (mm)	L1 (mm)	L2/L4 (mm)	L3 (mm)		Precio (€/ud.)
VS0593656	110/110/110	100/100/100	64	72	73	249	60	52	52	5	80,05

Reducción excéntrica

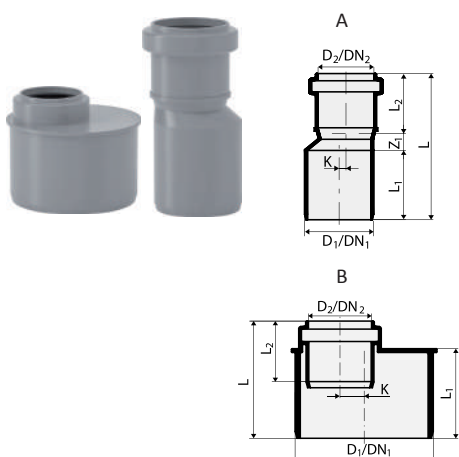

Referencia	Mod.	D/D2 (mm)	DN/DN2 (mm)	K (mm)	Z1 (mm)	L (mm)	L1 (mm)	L2 (mm)		Precio (€/ud.)
VS0593705	A	50/40	50/40	5	13	125	51	58	50	3,89
VS0593707	B	75/40	70/40	9	-	74	56	39	30	4,84
VS0593709	B	75/50	70/50	5	50	75	59	58	30	4,84
VS0593713	B	90/50	90/50	11	-	78	61	42	20	6,69
VS0593715	A	90/75	90/70	7	13	122	55	54	20	7,12
VS0593717	B	110/40	100/40	21,5	-	83	66	47	20	7,12
VS0593719	B	110/50	100/50	9	50	82	66	54	20	7,12
VS0593729	A	125/110	125/100	7	12	138	64	62	20	12,90
VS0593731	B	160/110	150/100	10	-	103	85	52	20	19,27
VS0593733	B	160/125	150/125	4	80	160	92	82	20	19,27
VS0593739	A	200/160	200/150	18	45	93	77	215	1	163,69
VS0593747	A	250/200	250/200	23	51	124	135	310	1	244,60

Accesorios FIREPLUS en PP fonoabsorbente

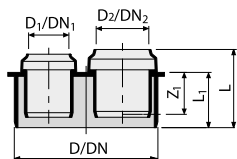

Reductor corto doble

Referencia	D/D1/D2 (mm)	DN/DN1/DN2 (mm)	Z1 (mm)	L (mm)	L1 (mm)		Precio (€/ud.)
VS0593990	110/40/40	100/40/40	30	60	42	15	32,18

Manguito de reducción

Referencia	D/D2 (mm)	D/DN2 (mm)	L (mm)	L1 (mm)		Precio (€/ud.)
VS0593795	90/110	90/110	81,5	65	20	8,12

Manguito deslizante

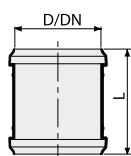

Referencia	D (mm)	DN (mm)	L (mm)		Precio (€/ud.)
VS0593803	40	40	108	30	3,42
VS0593805	50	50	108	30	3,75
VS0593807	75	70	120	20	4,98
VS0593809	90	90	120	20	7,69
VS0593811	110	100	136	20	8,54
VS0593813	125	125	147	20	15,97
VS0593815	160	150	204	10	24,09
VS0593817	200	200	220	1	132,35
VS0593819	250	250	290	1	256,01

Manguito con tope

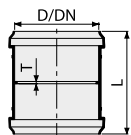

Referencia	D (mm)	DN (mm)	L (mm)	T (mm)		Precio (€/ud.)
VS0593853	40	40	108	2	30	3,42
VS0593855	50	50	108	2	30	3,75
VS0593857	75	70	120	2	20	5,73
VS0593859	90	90	120	2	20	7,99
VS0593861	110	100	136	3	20	8,54
VS0593863	125	125	147	3	20	15,97
VS0593865	160	150	210	28	10	24,09
VS0593867	200	200	200	4	1	132,35
VS0593869	250	250	250	4	1	256,01

Inspección lineal con tapón

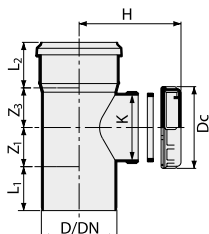

Referencia	D (mm)	DN (mm)	Z1 (mm)	Z3 (mm)	L1 (mm)	L2 (mm)	K (mm)	Dc (mm)	H (mm)		Precio (€/ud.)
VS0593901	50	50	28	30	82	54	75	90	83	20	11,65
VS0593907	110	100	57	62	61	67	105	118	100	15	22,21
VS0593909	125	125	58	63	67	69	120	149	126	10	43,47
VS0593911	160	150	58	64	93	83	120	149	126	5	66,91

Tapón

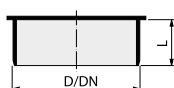

Referencia	D (mm)	DN (mm)	L (mm)		Precio (€/ud.)
VS0593959	110	100	40	20	10,87
VS0593961	125	125	47	10	14,46
VS0593963	160	150	48	10	18,00



 **SILERE**



Sistema en PP
con carga mineral.
Máximo confort
acústico

Sistema de tuberías y accesorios de polipropileno monocapa con carga mineral para evacuación insonorizada

El sistema **SILERE** se compone de la tubería y los accesorios en polipropileno monocapa con carga mineral para evacuación de aguas residuales y pluviales por gravedad a baja y alta temperatura. Máximo nivel de insonorización.



Boca con junta elastomérica monolabial

Velocidad y facilidad en la instalación.
Asegura la estanqueidad hidráulica y deslizamiento debido a las dilataciones térmicas.



Monocapa

PP reforzado con carga mineral en todo su espesor mejorando las prestaciones acústicas.

Características

- Máximas prestaciones acústicas. Certificado Fraunhofer P-B 223/2006e con nivel de fonoabsorbencia 6 dB con caudal de descarga 2 l/s según EN 14366.
- Producto libre de halógenos.
- Sistema de unión por junta elastomérica monolabial.

Aplicaciones

- Evacuación de aguas residuales en el interior del edificio hasta 95 °C.
- Ventilación primaria, secundaria y terciaria.
- Aspiraciones centralizadas.
- Ventilación de gases de chimeneas.
- Sistemas gravitatorios industriales.
- Evacuación de condensados de circuitos de climatización.

La instalación

Sistema de unión mediante boca con junta elastomérica monolabial

El sistema **SILERE** garantiza una instalación rápida y sin el uso de adhesivos, equipos eléctricos o maquinaria especial gracias al sistema de unión con junta labial.



Sistema de unión mediante manguito corredizo

El sistema **SILERE** dispone del manguito corredizo, el acoplamiento idóneo que permite la unión de dos tubos. Este sistema permite la recuperación de tubos, modificación de instalación y la realización de reparaciones.



Tuberías en polipropileno monocapa con carga mineral evacuación insonorizada

Tubo con 1 boca

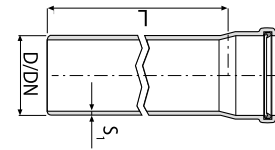

Referencia	D (mm)	DN (mm)	Espesor S1 (mm)	L (mm)		Precio (€/ud.)
VS0220007	58	50	4,0	1000	16	26,46
VS0220009	58	50	4,0	2000	16	47,10
VS0220011	58	50	4,0	3000	16	67,69
VS0220027	78	70	4,5	1000	16	27,86
VS0220029	78	70	4,5	2000	16	49,45
VS0220031	78	70	4,5	3000	16	71,00
VS0220047	90	90	4,5	1000	12	29,08
VS0220049	90	90	4,5	2000	12	57,11
VS0220050	90	90	4,5	3000	12	84,06
VS0220053	110	100	5,4	250	4	14,59
VS0220055	110	100	5,4	500	4	22,19
VS0220057	110	100	5,4	1000	15	36,46
VS0220059	110	100	5,4	2000	15	65,34
VS0220061	110	100	5,4	3000	15	95,43
VS0220077	135	125	5,6	1000	8	52,40
VS0220081	135	125	5,6	3000	8	130,63
VS0220097	160	150	5,6	1000	8	65,99
VS0220101	160	150	5,6	3000	8	176,28

Referencias de tubo disponibles en stock, para otros largos de tubo consultar en atencionalcliente@italsan.com o en el 900 921 957

Accesorios en polipropileno monocapa con carga mineral evacuación insonorizada

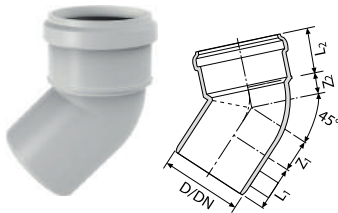

Codo 45°

Referencia	D (mm)	DN (mm)	Z1 (mm)	L1 (mm)	Z2 (mm)	L2 (mm)		Precio (€/ud.)
VS0221005	58	50	28	70	17	55	4	15,48
VS0221015	78	70	37	60	21	60	4	16,17
VS0221025	90	90	22	60	20	60	4	20,62
VS0221035	110	100	44	61	28	65	4	22,44
VS0221045	135	125	50	64	34	70	4	33,33
VS0221055	160	150	30	66	42	70	4	44,79

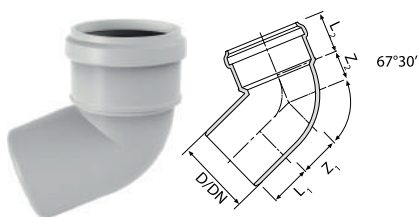

Codo 67° 30'

Referencia	D (mm)	DN (mm)	Z1 (mm)	L1 (mm)	Z2 (mm)	L2 (mm)		Precio (€/ud.)
VS0221007	58	50	32	70	21	50	4	14,56
VS0221017	78	70	26	60	26	70	4	15,26
VS0221037	110	100	44	61	44	100	4	21,03

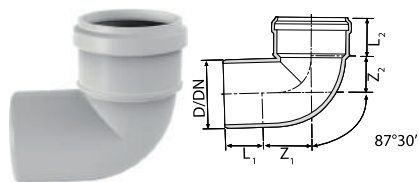

Codo 87° 30'

Referencia	D (mm)	DN (mm)	Z1 (mm)	L1 (mm)	Z2 (mm)	L2 (mm)		Precio (€/ud.)
VS0221009	58	50	47	70	32	55	4	16,57
VS0221019	78	70	62	60	42	60	4	16,57
VS0221029	90	90	49	60	42	60	4	21,94
VS0221039	110	100	78	61	58	65	4	23,54
VS0221049	135	125	96	64	102	70	4	38,00
VS0221059	160	150	83	66	89	70	4	53,56

Accesorios en polipropileno monocapa con carga mineral evacuación insonorizada

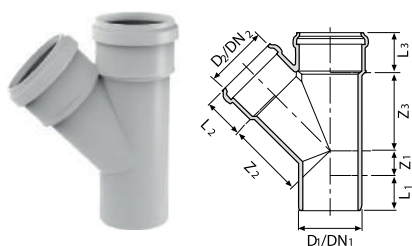

Derivación 45°

Referencia	D ₁ /D ₂ (mm)	DN ₁ /DN ₂ (mm)	Z ₁ (mm)	L ₁ (mm)	Z ₂ (mm)	L ₂ (mm)	Z ₃ (mm)	L ₃ (mm)		Precio (€/ud.)
VS0222005	58/58	50/50	12	70	75	55	75	55	4	27,93
VS0222009	78/78	70/70	16	60	99	60	99	60	4	30,21
VS0222011	90/58	80/50	19	60	113	60	113	55	4	35,60
VS0222013	90/90	90/90	19	60	116	60	113	60	4	29,90
VS0222015	110/58	100/50	1	61	110	65	97	55	4	34,67
VS0222017	110/78	100/70	21	61	122	65	115	60	4	37,87
VS0222018	110/90	100/80	44	61	168	60	136	70	4	41,34
VS0222019	110/110	100/100	44	61	136	70	136	70	4	43,06
VS0222021	135/110	125/100	49	64	169	70	169	65	2	62,85
VS0222023	135/135	125/125	49	64	169	70	169	70	2	78,24
VS0222025	160/110	150/100	36	95	180	70	200	70	2	84,70
VS0222027	160/160	150/150	36	95	200	70	200	70	2	109,98

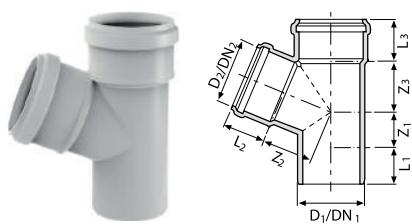

Derivación 67° 30'

Referencia	D ₁ /D ₂ (mm)	DN ₁ /DN ₂ (mm)	Z ₁ (mm)	L ₁ (mm)	Z ₂ (mm)	L ₂ (mm)	Z ₃ (mm)	L ₃ (mm)		Precio (€/ud.)
VS0223015	110/58	100/50	11	61	75	65	65	55	4	31,34
VS0223019	110/110	100/100	58	61	84	70	84	70	4	38,21

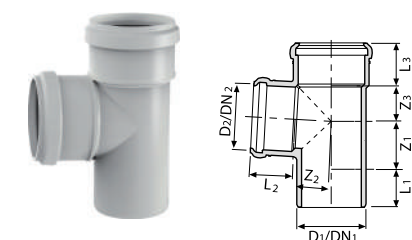

Derivación 87° 30'

Referencia	D ₁ /D ₂ (mm)	DN ₁ /DN ₂ (mm)	Z ₁ (mm)	L ₁ (mm)	Z ₂ (mm)	L ₂ (mm)	Z ₃ (mm)	L ₃ (mm)		Precio (€/ud.)
VS0224005	58/58	50/50	28	70	32	55	32	55	4	29,44
VS0224009	78/78	70/70	37	60	43	60	43	60	4	30,21
VS0224015	110/58	100/50	47	61	61	65	27	55	4	34,78
VS0224017	110/78	100/70	60	61	61	65	43	55	4	37,81
VS0224019	110/110	100/100	78	61	58	70	58	70	4	43,06
VS0224021	135/110	125/100	90	64	72	70	72	65	2	62,85
VS0224023	135/135	125/125	90	64	72	70	72	70	2	78,97

Accesorios en polipropileno monocapa con carga mineral evacuación insonorizada

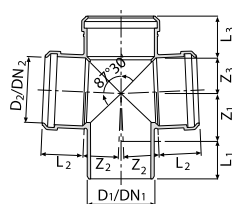

Derivación doble 87° 30'

Referencia	D ₁ /D ₂ (mm)	DN ₁ /DN ₂ (mm)	Z ₁ (mm)	L ₁ (mm)	Z ₂ (mm)	L ₂ (mm)	Z ₃ (mm)	L ₃ (mm)		Precio (€/ud.)
VS0225011 *	110/110	100/100	78	61	58	70	58	70	2	106,12
VS0225013 *	135/110	125/100	80	84	74	71	72	70	2	146,31

(*) Derivación manipulada

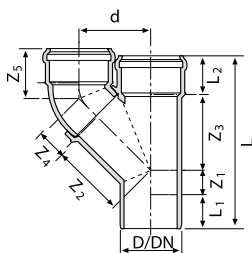

Derivación paralela

Referencia	D (mm)	DN (mm)	Z ₁ (mm)	Z ₂ (mm)	Z ₃ (mm)	Z ₄ (mm)	Z ₅ (mm)	D (mm)	L ₁ (mm)	L (mm)		Precio (€/ud.)
VS0233011	110	100	100	100	100	100	100	100	100	100	2	151,52

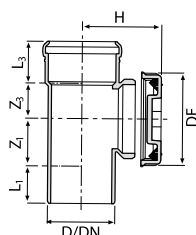

Inspección con tapón roscado

Referencia	D (mm)	DN (mm)	Z ₁ (mm)	L ₁ (mm)	Z ₃ (mm)	L ₃ (mm)	H (mm)	DE (mm)		Precio (€/ud.)
VS0227005	58	50	28	70	32	55	72	90	4	35,38
VS0227007	78	70	37	60	43	60	82	120	4	38,65
VS0227011	110	100	78	61	58	70	110	150	4	54,46
VS0227013	135	125	90	64	72	65	115	150	4	113,19
VS0227015	160	150	80	95	80	70	120	150	2	143,28

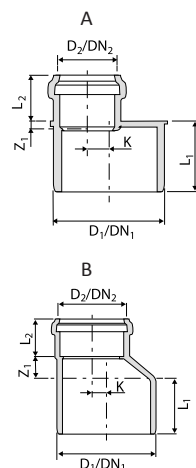

Reducción excéntrica

Referencia	Mod.	D ₁ /D ₂ (mm)	DN ₁ /DN ₂ (mm)	K (mm)	Z ₁ (mm)	L ₁ (mm)	L ₂ (mm)		Precio (€/ud.)
VS0226005	A	78/58	70/50	5	10	60	55	4	11,10
VS0226007	A	90/58	90/50	11	10	67	55	4	15,66
VS0226009	A	90/78	90/70	0	15	67	60	4	16,39
VS0226011	A	110/58	100/50	22	10	70	55	4	14,36
VS0226013	A	110/78	100/70	11	10	70	60	4	14,56
VS0226015	A	110/90	100/90	5	10	70	60	4	18,81
VS0226017	B	135/110	125/100	7	15	85	65	4	23,96
VS0226019	B	160/110	150/100	23	35	90	65	4	31,74
VS0226021	B	160/135	150/125	10	32	90	70	4	35,60

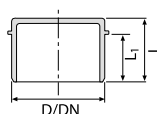

Tapón

Referencia	D (mm)	DN (mm)	L ₁ (mm)	L (mm)		Precio (€/ud.)
VS0230005	58	50	50	65	4	7,82
VS0230007	78	70	51	66	4	11,27
VS0230009	90	90	51	66	4	14,05
VS0230011	110	100	56	72	4	16,83
VS0230013	135	125	60	77	4	24,62
VS0230015	160	150	45	63,5	4	31,74

Accesorios en polipropileno monocapa con carga mineral evacuación insonorizada

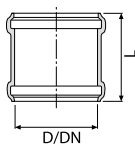

Manguito deslizante

Referencia	D (mm)	DN (mm)	L (mm)		Precio (€/ud.)
VS0228005	58	50	105	4	9,90
VS0228007	78	70	107	4	10,21
VS0228011	110	100	117	4	13,63
VS0228013	135	125	126	4	22,44
VS0228015	160	150	147	4	27,28

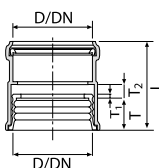

Manguito unido doble boca

Referencia	D (mm)	DN (mm)	T (mm)	T1 (mm)	T2 (mm)	L (mm)		Precio (€/ud.)
VS0229005	58	50	48	5	15	119	4	6,81
VS0229009	90	90	47	6	16	124	4	8,13
VS0229011	110	100	48	6	16	124	4	8,59

Adaptadores entre distintos sistemas

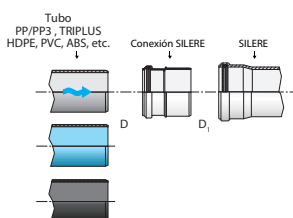

Adaptador SILERE, boca hembra con junta unión polivalente - macho unión SILERE

Referencia	D1/D2 (mm)	DN1/DN2 (mm)	Z1 (mm)	L (mm)	L1 (mm)		Precio (€/ud.)
VS0231001	58/40	50/40	30	67	50	4	10,29
VS0231003	58/50	50/50	25	86	60	4	10,39
VS0231005	78/50	70/50	37	80	60	4	10,63
VS0231007	78/75	70/70	0	116	60	4	10,63
VS0231013	135/125	125/125	0	138	72,5	2	16,26

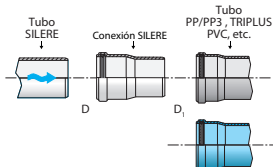

Adaptador SILERE, boca hembra unión SILERE - macho unión polivalente

Referencia	D1/D2 (mm)	DN1/DN2 (mm)	Z1 (mm)	L (mm)	S1 (mm)		Precio (€/ud.)
VS0237003	58/50	50/50	145	60	2,5	4	27,94
VS0237007	78/75	70/70	150	70	3,5	4	28,40
VS0237013	135/125	125/125	190	75	3,5	2	75,18



BOTES SIFÓNICOS PP



Sifones y
botes sifónicos PP

Sifón colector en línea

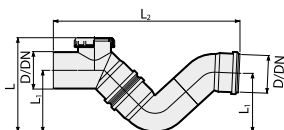

Sifón Colector en línea Macho/Hembra con registro

Referencia	D (mm)	DN (mm)	L (mm)	L1 (mm)	L2 (mm)		Precio (€/ud.)
VS0533050	50	50	165	110	380	1	38,22
VS0533075	75	70	215	135	420	1	46,63
VS0533110	110	100	280	180	535	1	65,52
VS0533125	125	125	310	200	610	1	119,45
VS0533160	160	150	350	250	700	1	227,31

Sifón para plato de ducha extraplano

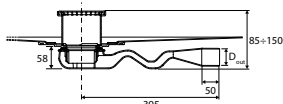
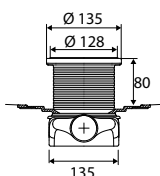
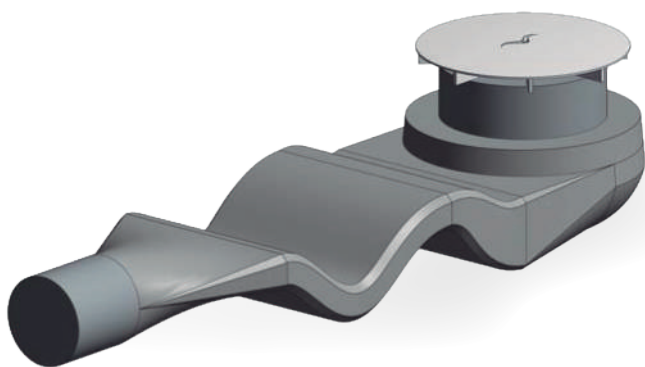

Sifón para plato de ducha extraplano T-58

Referencia	Dout (mm)	Conexión		Precio (€/ud.)
VS0700388	50	Horizontal	1	Consultar

Sifones y botes sifónicos en polipropileno

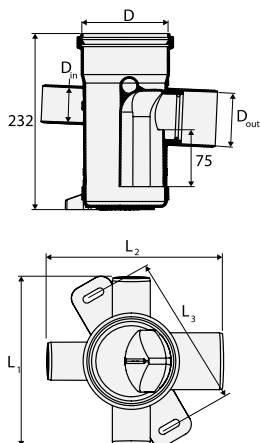

Bote sifónico TRIPLUS inspeccionable

Referencia	D (mm)	D _{in} (mm)	D _{out} (mm)	L ₁ /L ₂ /L ₃ (mm)		Precio (€/ud.)
VS0701741	110	3 x 50	1 x 75	220/230/200	5	65,89

- Bote sifónico Triplus formado por tres entradas de Ø 50mm y una salida de 75mm. Las entradas son ciegas a efectos de ser perforadas en función de las necesidades.
- Incluye sello hidráulico. Altura de sello hidráulico de 75 mm.
- Conexiones directas con bocas hembra mediante junta elástica.
- Se incluye el sistema de soportación inferior que lo hace 360º orientable y ajustable a la altura respecto a forjado.

COMPLEMENTOS BOTE SIFÓNICO TRIPLUS INSPECCIONABLE

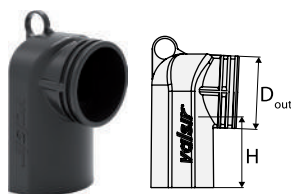

Sello hidráulico para bote TRIPLUS

Referencia	D _{out} (mm)	H (mm)		Precio (€/ud.)
VS0701702	75	75	1	9,05

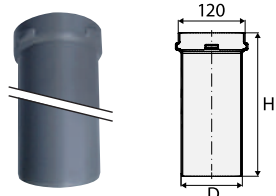

Prolongador en PP de 500 mm y 150 mm

Referencia	D (mm)	H (mm)		Precio (€/ud.)
VS0701031	110	500	10	11,01
VS0701032	110	150	10	8,38

Compatibles directamente con bote sifónico TRIPLUS ref. VS0701741 sin necesidad de junta.

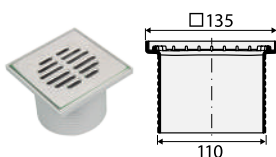

Prolongador completo con rejilla cuadrada 135 x 135 en acero inoxidable

Referencia	Dimensiones (mm)		Precio (€/ud.)
VS0701660	135 x 135	1	21,95

Compatible directamente con bote sifónico TRIPLUS ref. VS0701741 sin necesidad de junta.

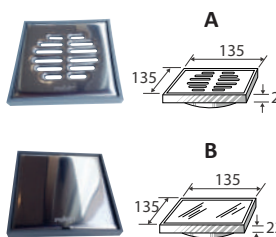

Tapa cuadrada inox, modelo rejilla y modelo ciega.

Referencia	Tipo	Dimensiones (mm)	Grosor tapa (mm)		Precio (€/ud.)
VS0701205	A	135 x 135	22	15	14,22
VS0701207	B	135 x 135	22	15	14,22

Compatibles con prolongador ref. VS0701031 y VS0701032.

No compatible directamente en bote sifónico TRIPLUS ref. VS0701741.

Sifones y botes sifónicos en polipropileno



Bote sifónico en polipropileno inspeccionable

Referencia	D Salida (mm)	D Entrada (mm)	H (mm)	H1 (mm)	H2 (mm)		Precio (€/ud.)
VS0701011	50	4x40	100	40	40	10	13,58
VS0701015	50	4x40	145	40	40	10	14,22

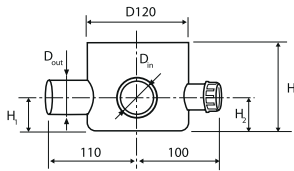

- Bote sifónico formado por cuatro entradas de Ø 40 mm y una salida de 50 mm.
- El bote incluye una tapa protectora superior, 2 tapas ciegas, 4 tuercas y 4 juntas cónicas para las conexiones de entrada.
- No incluye tapón con válvula para sello hidráulico ref. VS0701301.
- No admite conexión a prolongador.

COMPLEMENTOS BOTE SIFÓNICO REF. VS0701011 Y VS0701015

Tapón completo con válvula para sello hidráulico



Referencia	H (mm)		Precio (€/ud.)
VS0701301	75	10	9,32

Compatible con botes sifónicos ref. VS0701011 y ref. VS0701015.

Tapón completo con válvula para sello hidráulico + Rejilla redonda acero inox

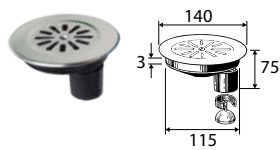

Referencia	D (mm)	H (mm)		Precio (€/ud.)
VS0701201	115	75	10	15,52

Compatible con botes sifónicos ref. VS0701011 y ref. VS0701015.

Tapa cuadrada inox, modelo rejilla y modelo ciega.

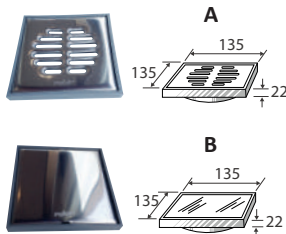

Referencia	Tipo	Dimensiones (mm)	Grosor tapa (mm)		Precio (€/ud.)
VS0701205	A	135 x 135	22	15	14,22
VS0701207	B	135 x 135	22	15	14,22

Compatibles con botes sifónicos ref. VS0701011 y ref. VS0701015.

RECAMBIOS

Tuerca



Referencia	Ø (mm)		Precio (€/ud.)
VS0701021	40	10	0,82

Válvula antiespumante



Referencia		Precio (€/ud.)
VS0703045	10	7,12

Tapón



Referencia	Ø (mm)		Precio (€/ud.)
VS0701023	40	10	1,14

Terminal cierre válvula



Referencia		Precio (€/ud.)
VS0701305	10	15,52

Junta cónica



Referencia	Ø (mm)		Precio (€/ud.)
VS0701025	40	10	0,73

Botes sifónicos PP

Sifones y botes sifónicos en polipropileno

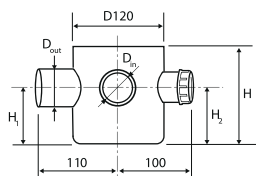

Bote sifónico en polipropileno inspeccionable

Referencia	D Salida (mm)	D Entrada (mm)	H (mm)	H1 (mm)	H2 (mm)		Precio (€/ud.)
VS0701050	50	4x40	125	75	75	10	16,55
VS0701075	75	4x40	125	75	75	10	19,42

- Bote sifónico formado por cuatro entradas de \varnothing 40mm y una salida de 50mm o 75mm.
- El bote incluye una tapa protectora superior, 2 tapas ciegas, 4 tuercas y 4 juntas cónicas para las conexiones de entrada.
- Las referencias VS0701050 y VS0701075 incluyen sello hidráulico extraíble con junta tórica (ref. sello hidráulico: VS0701150 y VS0701175, ref. juntas tóricas del sello hidráulico: VS0701350 y VS0701019).
- La conexión al prolongador es opcional y siempre mediante la junta ref. VS0701033.

COMPLEMENTOS BOTE SIFÓNICO REF. VS0701050 Y VS0701075

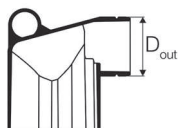

Sello hidráulico

Referencia	Dout (mm)		Precio (€/ud.)
VS0701150	50	10	1,81
VS0701175	75	15	2,88

Compatible con botes sifónicos ref. VS0701050 y VS0701075.

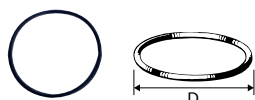

Junta tórica para sello hidráulico ref. VS0701150 y VS0701175

Referencia	D (mm)		Precio (€/ud.)
VS0701350	50	10	0,31
VS0701019	75	10	0,53

Compatible con botes sifónicos ref. VS0701050 y VS0701075.

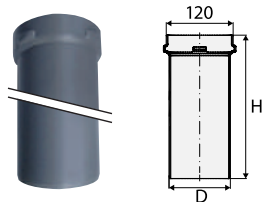

Prolongador en PP

Referencia	D (mm)	H (mm)		Precio (€/ud.)
VS0701031	110	500	10	11,01
VS0701032	110	150	10	8,38

Compatibles con botes sifónicos ref. VS0701050 y VS0701075 mediante la junta ref. VS0701033.



Junta para prolongador

Referencia	D (mm)		Precio (€/ud.)
VS0701033	110	100	3,08

Compatible con botes sifónicos ref. VS0701050 y VS0701075.

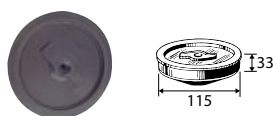

Tapón completo

Referencia	D (mm)	Altura tapón (mm)		Precio (€/ud.)
VS0701303	115	33	15	7,12

Compatible con botes sifónicos ref. VS0701050 y VS0701075.

Sifones y botes sifónicos en polipropileno

COMPLEMENTOS BOTE SIFÓNICO REF. VS0701050 Y VS0701075

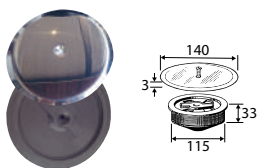

Tapón completo + Tapa ciega redonda acero inox

Referencia	D (mm)	H (mm)		Precio (€/ud.)
VS0701203	115	33	10	13,87

Compatible con botes sifónicos ref. VS0701050 y VS0701075.

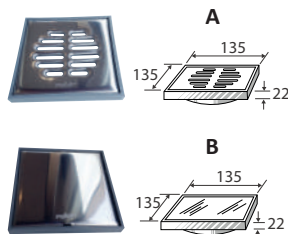

Tapa cuadrada inox, modelo rejilla y modelo ciega.

Referencia	Tipo	Dimensiones (mm)	Grosor tapa (mm)		Precio (€/ud.)
VS0701205	A	135 x 135	22	15	14,22
VS0701207	B	135 x 135	22	15	14,22

Compatibles directamente con botes sifónicos ref. VS0701050 y VS0701075.

Compatibles directamente con prolongador con ref. VS0701050 y VS0701075.

RECAMBIOS



Tuerca

Referencia	∅ (mm)		Precio (€/ud.)
VS0701021	40	10	0,82



Junta cónica

Referencia	∅ (mm)		Precio (€/ud.)
VS0701025	40	10	0,73



Tapón

Referencia	∅ (mm)		Precio (€/ud.)
VS0701023	40	10	1,14



 **PPECOFORTE**



Sistema de
evacuación en
PP-HM.
Evacuación y
saneamiento
enterrado

Tubos PP-HM

Tubo con 1 boca

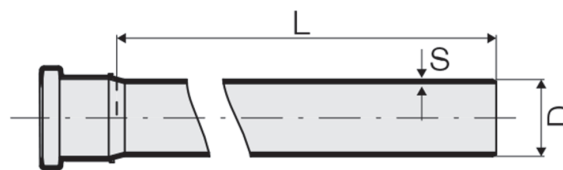

Referencia	Ø (mm)	S (mm)	L (mm)		Precio (€/ud.)
TUBO 1 BOCA SN4					
VSE010003	110	3,4	3000	30	63,24
VSE010013	125	3,9	3000	36	97,91
VSE010023	160	4,9	3000	14	134,65
VSE010033	200	6,2	3000	10	228,50
VSE010043	250	7,7	3000	8	371,31
VSE010053	315	7,7	3000	6	478,76
TUBO 1 BOCA SN8					
VSE010153	315	10,6	3000	6	599,80
VSE010163	400	13,5	3000	2	942,55
VSE010173	500	16,8	3000	2	1.448,50
TUBO 1 BOCA SN12					
VSE010253	315	11,6	3000	4	632,47
VSE010263	400	15,0	3000	2	1.011,90
VSE010273	500	18,6	3000	2	1.524,00
TUBO 1 BOCA SN16					
VSE010353	315	13,5	3000	4	709,99
VSE010363	400	16,9	3000	2	1.109,84
VSE010373	500	21,4	3000	2	1.746,36

Accesorios PP-HM

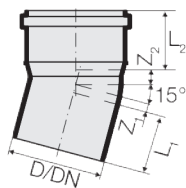

Curva 15°

Referencia	Ø (mm)	DN (mm)	Z1 (mm)	L1 (mm)	Z2 (mm)	L2 (mm)		Precio (€/ud.)
VSE010401	110	100	9	61	16	59	20	11,80
VSE010402	125	125	10	66	17	64	20	18,09
VSE010403	160	150	12	45	22	73	1	27,81
VSE010404 *	200	200	15	100	23	87	1	99,01
VSE010405 *	250	250	19	140	34	152	1	276,08
VSE010406 *	315	300	73	171	76	171	1	433,73
VSE010407 *	400	400	52	198	138	198	1	677,02
VSE010408 *	500	500	55	232	151	232	1	1.100,16

(*) Curvas manipuladas

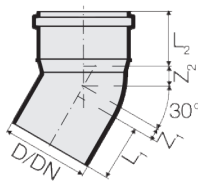

Curva 30°

Referencia	Ø (mm)	DN (mm)	Z1 (mm)	L1 (mm)	Z2 (mm)	L2 (mm)		Precio (€/ud.)
VSE010421	110	100	17	61	23	59	20	11,80
VSE010422	125	125	18	66	26	64	20	18,09
VSE010423	160	150	23	75	33	73	1	27,81
VSE010424 *	200	200	38	100	46	87	1	99,01
VSE010425 *	250	250	42	140	51	152	1	276,08
VSE010426 *	315	300	98	171	97	171	1	433,73
VSE010427 *	400	400	80	198	166	198	1	677,02
VSE010428	500	500	89	232	185	232	1	1.100,16

(*) Curvas manipuladas

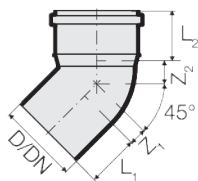

Curva 45°

Referencia	Ø (mm)	DN (mm)	Z1 (mm)	L1 (mm)	Z2 (mm)	L2 (mm)		Precio (€/ud.)
VSE010441	110	100	25	61	31	59	20	12,96
VSE010442	125	125	28	66	35	64	15	19,43
VSE010443	160	150	35	75	45	73	1	36,56
VSE010444	200	200	63	180	86	170	1	82,84
VSE010445	250	250	57	210	88	203	1	152,33
VSE010446 *	315	300	117	171	120	171	1	571,24
VSE010447 *	400	400	109	198	195	198	1	803,96
VSE010448 *	500	500	126	232	222	232	1	1.121,34

(*) Curvas manipuladas

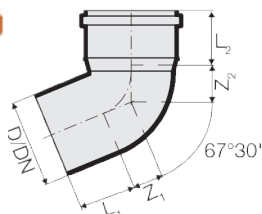

Curva 67°30'

Referencia	Ø (mm)	DN (mm)	Z1 (mm)	L1 (mm)	Z2 (mm)	L2 (mm)		Precio (€/ud.)
VSE010461	110	100	40	61	45	59	20	12,96
VSE010462	125	125	43	66	51	64	15	19,43

Curva 87°

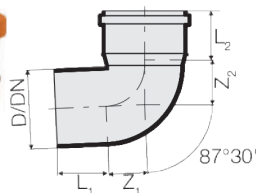

Referencia	Ø (mm)	DN (mm)	Z1 (mm)	L1 (mm)	Z2 (mm)	L2 (mm)		Precio (€/ud.)
VSE010481	110	100	57	61	61	59	20	15,24
VSE010482	125	125	62	66	70	64	10	25,13
VSE010483	160	150	78	75	89	73	1	42,65
VSE010484	200	200	148	180	172	170	1	82,84
VSE010485	250	250	122	210	163	203	1	152,33
VSE010486 *	315	300	234	171	240	171	1	592,40
VSE010487 *	400	400	278	198	364	198	1	846,27
VSE010488 *	500	500	322	232	418	232	1	1.184,81

(*) Curvas manipuladas

Accesorios PP-HM

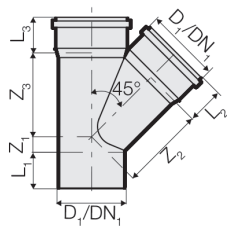

Derivación 45°

Referencia	D1/DN1 (mm)	Z1 (mm)	L1 (mm)	Z2 (mm)	L2 (mm)	Z3 (mm)	L3 (mm)		Precio (€/ud.)
VSE010501	110/110	25	61	135	59	135	59	10	28,57
VSE010502	125/125	28	66	152	65	152	65	5	38,10
VSE010503	160/160	36	75	198	73	199	73	1	64,75
VSE010504 *	200/200	66	132	278	132	302	132	1	504,61
VSE010505 *	250/250	100	160	370	160	344	160	1	647,40
VSE010506 *	315/315	130	171	434	171	449	171	1	894,95
VSE010507 *	400/400	213	198	552	170	590	198	1	1.375,20
VSE010508 *	500/500	150	232	718	232	718	232	1	2.919,68

(*) Derivaciones manipuladas

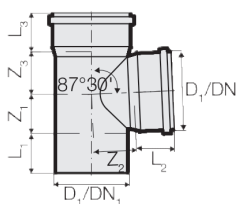

Derivación 87°

Referencia	D1/DN1 (mm)	Z1 (mm)	L1 (mm)	Z2 (mm)	L2 (mm)	Z3 (mm)	L3 (mm)		Precio (€/ud.)
VSE010521	110/110	56	61	65	59	65	59	10	28,57
VSE010522	125/125	65	66	71	65	71	65	10	38,10
VSE010523	160/160	80	75	94	73	97	73	1	64,75
VSE010524 *	200/200	160	132	150	132	139	132	1	504,61
VSE010525 *	250/250	175	160	185	160	165	160	1	647,40
VSE010526 *	315/315	359	171	234	171	220	171	1	894,95
VSE010527 *	400/400	296	198	300	170	257	198	1	1.375,20
VSE010528 *	500/500	530	232	378	232	338	232	1	2.919,68

(*) Derivaciones manipuladas

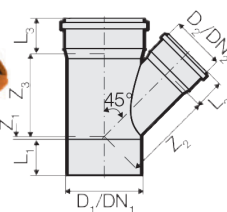

Derivación reducida 45°

Referencia	D1/D2 (mm)	DN1/DN2 (mm)	Z1 (mm)	L1 (mm)	Z2 (mm)	L2 (mm)	Z3 (mm)	L3 (mm)		Precio (€/ud.)
VSE010601	125/110	125/100	18	66	146	59	142	65	8	29,49
VSE010602	160/110	150/100	6	75	185	59	171	73	1	47,60
VSE010603 *	200/110	200/100	49	132	222	63	254	132	1	257,05
VSE010604 *	250/110	250/100	6	160	257	63	279	160	1	352,28
VSE010605 *	315/110	300/100	-3	171	303	63	360	171	1	495,08
VSE010607 *	160/125	150/125	12	75	184	65	174	73	1	57,13
VSE010608 *	200/125	200/125	49	132	240	68	254	132	1	257,05
VSE010609 *	250/125	250/125	6	160	275	68	279	160	1	352,28
VSE010610 *	315/125	300/125	-3	171	321	68	360	171	1	514,11
VSE010612 *	200/160	200/150	114	132	270	91	254	132	1	295,13
VSE010613 *	250/160	250/150	61	160	320	91	279	160	1	399,87
VSE010614 *	315/160	300/150	-2	171	349	91	360	171	1	533,18
VSE010616 *	250/200	250/200	69	160	320	132	344	160	1	447,47
VSE010617 *	315/200	300/200	26	171	355	132	449	171	1	580,76
VSE010619 *	315/250	300/250	130	171	395	160	449	171	1	761,66
VSE010615 *	400/160	400/150	-52	198	409	91	400	198	1	761,66
VSE010624 *	400/200	400/200	87	198	435	132	472	198	1	1.396,37
VSE010618 *	400/250	400/250	80	198	450	160	472	198	1	803,96
VSE010625 *	400/315	400/300	213	198	509	171	590	198	1	1.438,67
VSE010620 *	500/160	500/150	8	232	479	91	510	232	1	973,21
VSE010626 *	500/200	500/200	8	232	508	132	510	232	1	1.565,62
VSE010621 *	500/250	500/250	8	232	528	160	510	232	1	1.142,47
VSE010627 *	500/315	500/300	220	232	577	171	648	232	1	1.650,26
VSE010628 *	500/400	500/400	220	232	632	198	648	232	1	1.946,46

(*) Derivaciones manipuladas

Accesorios PP-HM

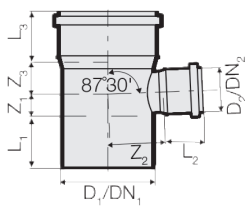

Derivación reducida 87°

Referencia	D1/D2 (mm)	DN1/DN2 (mm)	Z1 (mm)	L1 (mm)	Z2 (mm)	L2 (mm)	Z3 (mm)	L3 (mm)		Precio (€/ud.)
VSE010641	125/110	125/100	58	66	72	59	64	65	8	29,49
VSE010642	160/110	150/100	55	75	93	59	71	73	1	47,60
VSE010643 *	200/110	200/100	136	132	137	63	125	132	1	257,05
VSE010644 *	250/110	250/100	118	160	162	63	165	160	1	352,28
VSE010645 *	315/110	300/100	126	171	201	63	180	171	1	495,08
VSE010647 *	160/125	150/125	64	75	93	65	79	73	1	57,13
VSE010648 *	200/125	200/125	136	132	137	68	125	132	1	257,05
VSE010649 *	250/125	250/125	118	160	162	68	165	160	1	352,28
VSE010650 *	315/125	300/125	126	171	200	68	180	171	1	514,11
VSE010652 *	200/160	200/150	136	132	145	91	125	132	1	295,13
VSE010653 *	250/160	250/150	175	160	162	91	165	160	1	399,87
VSE010654 *	315/160	300/150	126	171	200	91	180	171	1	533,18
VSE010656 *	250/200	250/200	175	160	177	132	165	160	1	447,47
VSE010657 *	315/200	300/200	126	171	210	132	180	171	1	580,76
VSE010659 *	315/250	300/250	359	171	215	160	220	171	1	761,66
VSE010655 *	400/160	400/150	171	198	245	91	177	198	1	761,66
VSE010664 *	400/200	400/200	171	198	236	132	177	198	1	1.396,37
VSE010658 *	400/250	400/250	171	198	240	160	177	198	1	803,96
VSE010665 *	400/315	400/300	296	198	280	171	257	198	1	1.438,67
VSE010660 *	500/160	500/150	141	232	289	91	178	232	1	973,21
VSE010666 *	500/200	500/200	141	232	288	132	178	232	1	1.565,62
VSE010661 *	500/250	500/250	141	232	290	160	178	232	1	1.142,47
VSE010667 *	500/315	500/300	260	232	299	171	258	232	1	1.650,26
VSE010668 *	500/400	500/400	530	232	352	198	338	232	1	1.946,46

(*) Derivaciones manipuladas.

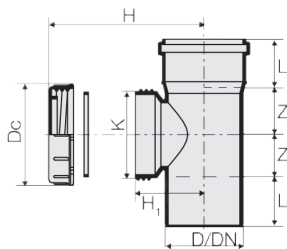

Inspección

Referencia	D/DN (mm)	Z1 (mm)	L1 (mm)	Z2 (mm)	L2 (mm)	H (mm)	Dc (mm)	K (mm)	H1 (mm)		Precio (€/ud.)
VSE010901	110/110	55	61	65	59	100	120	105	90	15	34,28
VSE010902	125/125	65	66	71	65	105	150	128	98	10	47,60
VSE010903	160/160	64	75	75	73	105	150	128	118	1	76,18
VSE010904 *	200/200	154	132	148	132	184	150	128	142	1	304,65
VSE010905 *	250/250	126	160	120	160	209	150	128	158	1	418,90
VSE010906 *	315/315	115	171	109	171	242	150	128	225	1	571,24
VSE010907 *	400/400	107	198	101	198	284	150	128	266	1	677,02
VSE010908 *	500/500	94	232	103	232	334	150	128	316	1	1.227,11

(*) Plezas manipuladas.

Reducción excéntrica

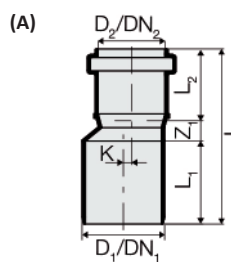

Referencia	D1/D2 (mm)	DN1/DN2 (mm)	Mod.	K (mm)	Z1 (mm)	L1 (mm)	L2 (mm)	L (mm)		Precio (€/ud.)
VSE010921	125/110	125/100	A	4	6	67	49	122	20	14,26
VSE010922	160/110	150/100	B	10	-	63	52	81	1	18,67
VSE010923	160/125	150/125	B	4	-	64	56	83	1	23,80
VSE010924 *	200/125	200/125	A	22	53	117	57	227	1	123,77
VSE010925 *	200/160	200/150	A	18	45	93	77	215	1	171,37
VSE010926 *	250/200	250/200	A	23	51	124	135	310	1	199,92

(*) Plezas manipuladas.

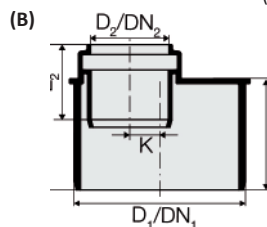

Sistema ECOFORTE

Índice

Accesorios PP-HM

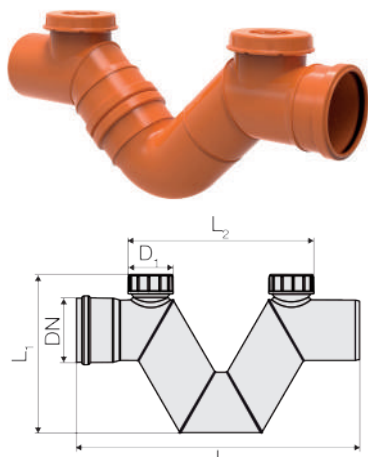

Sifón colector en línea macho/hembra con 2 registros

Referencia	D (mm)	L (mm)	L1 (mm)	L2 (mm)	D1 (mm)		Precio (€/ud.)
VSE010951	110	618	319	497	118	1	99,01
VSE010952	125	694	346	577	149	1	114,26
VSE010953	160	862	413	718	149	1	293,39
VSE010954	200	979	541	658	150	1	428,43
VSE010955	250	1128	638	712	150	1	1.218,64
VSE010956	315	1278	775	850	150	1	1.561,37

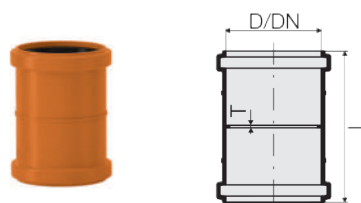

Manguito con tope

Referencia	D/DN (mm)	L (mm)	T (mm)		Precio (€/ud.)
VSE011001	110/100	136	3	20	13,33
VSE011002	125/125	147	3	20	20,00
VSE011003	160/150	180	3	1	32,38
VSE011004	200/200	220	4	1	57,13
VSE011005	250/250	290	4	1	133,30
VSE011006 *	315/300	385	-	1	645,29
VSE011007	400/400	492	-	1	1.163,62
VSE011008	500/500	575	-	1	1.861,82

(*) Piezas manipuladas.

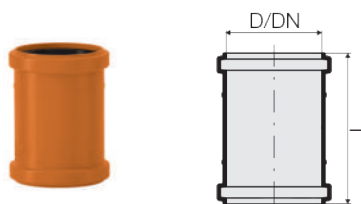

Manguito deslizante

Referencia	D/DN (mm)	L (mm)		Precio (€/ud.)
VSE011031	110/100	136	20	13,33
VSE011032	125/125	147	20	20,00
VSE011033	160/150	180	1	32,38
VSE011034	200/200	220	1	57,13
VSE011035	250/250	290	1	133,30

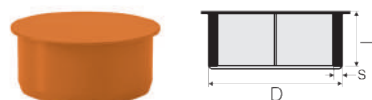

Tapón

Referencia	D (mm)	s (mm)	L (mm)		Precio (€/ud.)
VSE011201	110	3,2	38	20	4,78
VSE011202	125	3,2	42	10	8,95
VSE011203	160	4,0	49	10	9,53



WHITEMARINE
UV RESISTANT



Sistema de
evacuación de
aguas residuales
para instalaciones
sanitarias de
drenaje por
gravedad y vacío

Índice

Sistema de tuberías PP-H insonorizada con resistencia UV para instalaciones interiores y a la intemperie del sector naval y offshore

WHITE MARINE® es el sistema de acoplamiento formado por tubos, conexiones y accesorios industrializado, fabricado y patentado por Valsir para el sector náutico.

El sistema prevé tuberías formadas por tres capas distintas de material, cuya combinación permite conseguir un rendimiento mecánico muy elevado -incluso a bajas temperaturas- y garantiza unas excelentes propiedades de insonorización.

Capa intermedia

Está fabricada con una mezcla patentada a base de polipropileno (PP) y cargas minerales (MF) que confiere al sistema **WHITE MARINE®** unas excelentes propiedades mecánicas a bajas (resistencia al impacto hasta -25 °C) y altas temperaturas (hasta 95 °C).

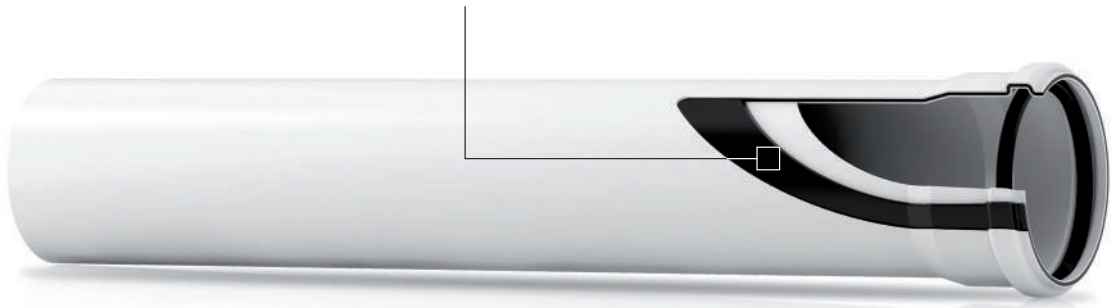

El sistema de descarga **WHITE MARINE®** puede transportar aguas residuales en temperatura con un pH comprendido entre 2 y 12, tiene una gran resistencia a los agentes químicos más comunes y se caracteriza por una superficie interna muy lisa, que previene la acumulación de depósitos dentro de las redes de alcantarillado.

Características

- Resistencia a los rayos UV: 800 klys (ISO 4892-2).
- El material ofrece una alta resistencia al impacto a bajas temperaturas (hasta -25 °C).
- Instalación extremadamente sencilla y rápida sin necesidad de herramientas especiales gracias a su conexión a presión.
- Las tuberías se suministran en varias longitudes.
- Resistencia a descargas intermitentes a temperaturas de hasta 95 °C.
- Alta resistencia química a las sustancias disueltas en las aguas residuales a bordo de los buques.
- Fácil conexión a otros sistemas de gestión de residuos (hierro fundido, PE, PP, PVC, etc.).
- Bajo coeficiente de expansión térmica.
- El producto, su reciclabilidad y los procesos de producción se basan en los principios de la Construcción Sostenible.

Tuberías HTEM

Tubo con 1 boca

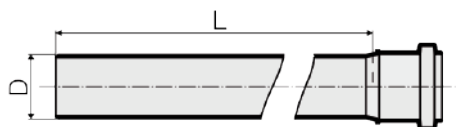

Referencia	D (mm)	Espesor (mm)	L (mm)		Precio (€/ud.)
VS0656043	50	1,8	250	30	4,80
VS0656045	50	1,8	500	35	6,85
VS0656047	50	1,8	1000	30	9,86
VS0656049	50	1,8	1500	30	16,13
VS0656051	50	1,8	2000	30	20,40
VS0656053	50	1,8	3000	30	31,91
VS0656063	75	2,6	250	20	8,58
VS0656065	75	2,6	500	20	11,58
VS0656067	75	2,6	1000	20	16,65
VS0656069	75	2,6	1500	20	23,68
VS0656071	75	2,6	2000	20	31,13
VS0656073	75	2,6	3000	20	46,14
VS0656083	90	3,1	250	24	10,30
VS0656085	90	3,1	500	24	15,52
VS0656087	90	3,1	1000	10	24,45
VS0656089	90	3,1	1500	10	33,79
VS0656091	90	3,1	2000	10	46,40
VS0656093	90	3,1	3000	10	67,15
VS0656103	110	3,4	250	15	11,33
VS0656105	110	3,4	500	15	17,41
VS0656107	110	3,4	1000	15	27,19
VS0656109	110	3,4	1500	15	38,00
VS0656111	110	3,4	2000	15	51,38
VS0656113	110	3,4	3000	15	74,55
VS0656123	125	3,9	250	11	16,91
VS0656125	125	3,9	500	6	24,45
VS0656127	125	3,9	1000	8	39,54
VS0656129	125	3,9	1500	8	54,04
VS0656131	125	3,9	2000	8	72,91
VS0656133	125	3,9	3000	8	103,19
VS0656143	160	4,9	250	6	24,45
VS0656145	160	4,9	500	6	38,00
VS0656147	160	4,9	1000	6	59,19
VS0656149	160	4,9	1500	6	81,66
VS0656151	160	4,9	2000	6	109,97
VS0656153	160	4,9	3000	6	157,74
VS0656173	200	6,2	3000	4	335,30

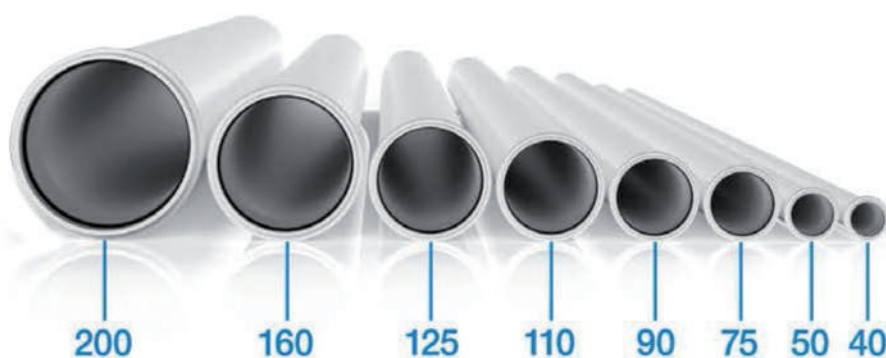

Accesorios

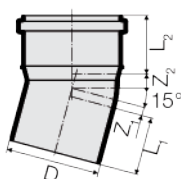

Codo 15°

Referencia	D (mm)	Z1 (mm)	L1 (mm)	Z2 (mm)	L2 (mm)		Precio (€/ud.)
VS0656421	50	4	48	8	46	30	5,23
VS0656431	75	7	53	11	52	20	8,32
VS0656441	90	8	56	14	56	20	11,33
VS0656451	110	9	61	16	59	20	12,62
VS0656461	125	10	66	17	64	20	23,68
VS0656471	160	12	45	22	73	1	36,97

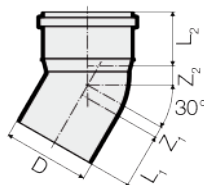

Codo 30°

Referencia	D (mm)	Z1 (mm)	L1 (mm)	Z2 (mm)	L2 (mm)		Precio (€/ud.)
VS0656423	50	8	48	12	46	30	5,23
VS0656433	75	12	58	17	52	20	8,32
VS0656443	90	14	56	20	56	20	11,33
VS0656453	110	17	61	23	59	20	12,62
VS0656463	125	18	66	26	64	20	23,68
VS0656473	160	23	75	33	73	1	36,97

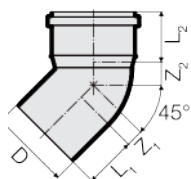

Codo 45°

Referencia	D (mm)	Z1 (mm)	L1 (mm)	Z2 (mm)	L2 (mm)		Precio (€/ud.)
VS0656425	50	11	48	17	46	50	4,80
VS0656435	75	18	53	22	52	20	8,32
VS0656445	90	21	56	26	56	20	11,33
VS0656455	110	25	61	31	59	20	11,85
VS0656465	125	28	66	35	64	15	23,68
VS0656475	160	35	75	45	73	1	36,97

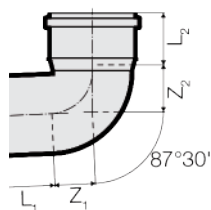

Codo 87° 30'

Referencia	D (mm)	Z1 (mm)	L1 (mm)	Z2 (mm)	L2 (mm)		Precio (€/ud.)
VS0656429	50	26	48	30	46	30	5,31
VS0656439	75	40	53	43	52	20	10,81
VS0656449	90	46	56	51	56	20	12,00
VS0656459	110	57	61	61	59	20	12,62
VS0656469	125	62	66	70	64	10	34,73
VS0656479	160	78	75	89	73	1	57,39

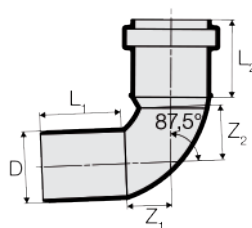

Codo 87° 30' radio largo

Referencia	D (mm)	Z1 (mm)	L1 (mm)	Z2 (mm)	L2 (mm)		Precio (€/ud.)
VS0656972	50	31	46	37	45	30	5,41
VS0656973	75	48	56	54	52	15	10,98
VS0656974	90	57	56	64	56	20	12,26
VS0656975	110	69	64	78	59	20	12,70

Accesorios

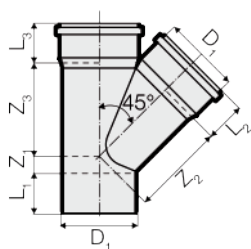

Derivación 45°

Referencia	D1 (mm)	Z1 (mm)	L1 (mm)	Z2 (mm)	L2 (mm)	Z3 (mm)	L3 (mm)		Precio (€/ud.)
VS0656513	50	12	50	61	46	61	46	20	10,56
VS0656519	75	19	53	96	52	96	52	20	14,58
VS0656525	90	21	56	110	56	110	56	20	22,06
VS0656531	110	25	61	135	59	135	59	10	24,70
VS0656537	125	28	66	152	65	152	65	5	85,51
VS0656543	160	36	75	198	73	199	73	1	133,30

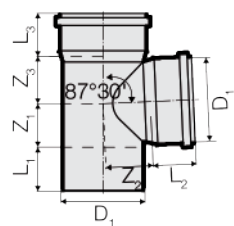

Derivación 87°30'

Referencia	D1 (mm)	Z1 (mm)	L1 (mm)	Z2 (mm)	L2 (mm)	Z3 (mm)	L3 (mm)		Precio (€/ud.)
VS0656517	50	28	50	29	46	29	46	20	10,56
VS0656523	75	39	53	46	52	46	52	20	14,58
VS0656529	90	48	56	52	56	52	56	20	22,06
VS0656535	110	56	61	65	59	65	59	10	24,70
VS0656541	125	65	66	71	65	71	65	5	85,51
VS0656547	160	80	75	94	73	97	73	1	133,30

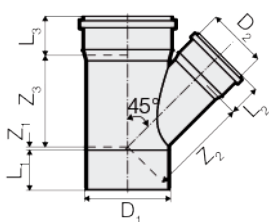

Reducción 45°

Referencia	D1/D2 (mm)	Z1 (mm)	L1 (mm)	Z2 (mm)	L2 (mm)	Z3 (mm)	L3 (mm)		Precio (€/ud.)
VS0656569	75/50	-1	54	84	46	76	54	25	14,58
VS0656581	90/50	-3	56	93	46	82	56	20	22,06
VS0656593	110/50	-17	61	110	46	92	59	20	24,70
VS0656599	110/75	1	61	123	52	110	59	15	24,70
VS0656689*	110/90	12	61	162	60	135	59	10	37,80
VS0656605	125/50	-24	66	114	46	111	65	10	56,35
VS0656611	125/110	18	66	146	59	142	65	8	56,35
VS0656617	160/110	6	75	185	59	171	73	1	88,77
VS0656623	160/125	12	75	184	65	174	73	1	88,77

(*) Pieza manipulada.

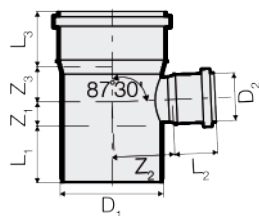

Reducción 87°30'

Referencia	D1/D2 (mm)	Z1 (mm)	L1 (mm)	Z2 (mm)	L2 (mm)	Z3 (mm)	L3 (mm)		Precio (€/ud.)
VS0656573	75/50	27	53	46	46	35	52	25	14,58
VS0656585	90/50	28	56	55	46	39	56	20	22,06
VS0656597	110/50	28	61	67	46	47	59	20	24,70
VS0656603	110/75	43	61	67	52	49	59	15	24,70
VS0656691*	110/90	56	61	90	60	65	59	10	27,87
VS0656609	125/50	28	66	68	46	36	65	10	56,35
VS0656615	125/110	58	66	72	59	64	65	8	56,35
VS0656621	160/110	55	75	93	59	71	73	1	88,77
VS0656627	160/125	64	75	92	65	78	73	1	88,77

(*) Pieza manipulada.

Accesorios

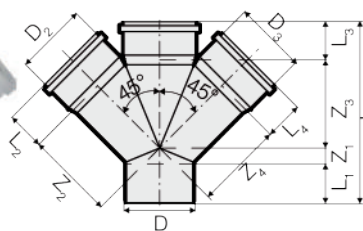

Derivación doble 45°

Referencia	D1/ D2/ D3 (mm)	L (mm)	Z1 (mm)	L1 (mm)	Z2/3/4 (mm)	L2/3/4 (mm)		Precio (€/ud.)
VS0656655	110/110/110	280	25	61	136	59	5	49,32

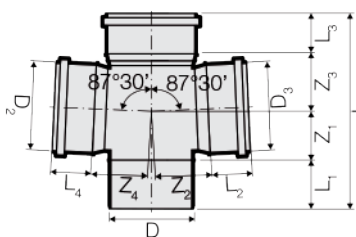

Derivación doble 87°30'

Referencia	D1/ D2/ D3 (mm)	L (mm)	Z1 (mm)	L1 (mm)	Z2/4 (mm)	L2/4 (mm)	Z3 (mm)	L3 (mm)		Precio (€/ud.)
VS0656654*	110/50/50	181,5	25	60	63	44	42,5	54	5	98,55
VS0656656	110/110/110	249	64	60	72	52	73	52	5	98,55

(*) Pieza manipulada.

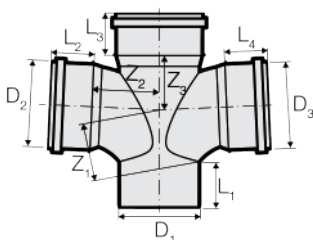

Derivación doble 87°30' compacta

Referencia	D1/ D2/ D3 (mm)	Z1 (mm)	L1 (mm)	Z2 (mm)	L2 (mm)	Z3 (mm)	L3 (mm)	L4 (mm)		Precio (€/ud.)
VS0656980	90/90/75	57	56	64	56	47	56	53	15	82,35
VS0656981	90/90/90	57	56	64	56	47	56	56	12	82,35
VS0656982	110/110/75	69	64	78	66	58	59	52	5	91,43
VS0656983	110/110/90	69	64	78	66	58	59	56	5	94,79
VS0656984	110/110/110	69	64	78	66	58	59	59	5	98,55

Derivación doble 87°30' en ángulo

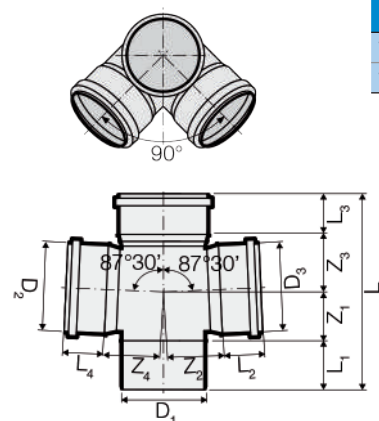

Referencia	D1/ D2/ D3 (mm)	L (mm)	Z1 (mm)	L1 (mm)	Z2/4 (mm)	L2/4 (mm)	Z3 (mm)	L3 (mm)		Precio (€/ud.)
VS0656657	110/110/110	242	54	63	77	54	71	54	5	103,19
VS0656661	125/110/110	255	54	77	71	71	54	59	5	120,60

Accesorios

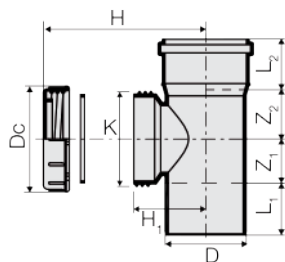

Inspección tapón roscado

Referencia	D (mm)	Z1 (mm)	L1 (mm)	Z2 (mm)	L2 (mm)	H (mm)	Dc (mm)	K (mm)	H1 (mm)		Precio (€/ud.)
VS0656901	50	36	48	35	46	60	90	74	57	20	18,88
VS0656903	75	40	53	43	52	80	90	74	66	20	23,16
VS0656905	90	49	58	55	56	90	120	105	80	20	30,62
VS0656907	110	55	61	65	59	100	120	105	90	15	36,03
VS0656909	125	65	66	71	65	105	150	128	98	10	70,41
VS0656911	160	64	75	75	73	105	150	128	118	1	108,42

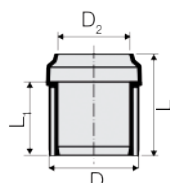

Manguito reductor

Referencia	D/ D2 (mm)	L (mm)	L1 (mm)		Precio (€/ud.)
VS0656797	125/110	86	68	30	27,87

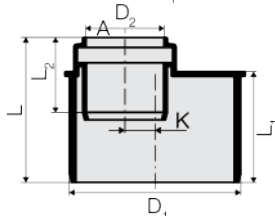
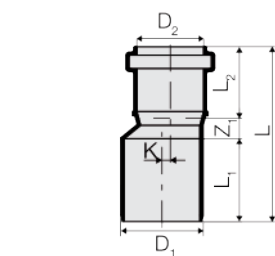

Reducción excéntrica

Referencia	Mod.	D1/D2 (mm)	K (mm)	Z1 (mm)	L1 (mm)	L2 (mm)	L (mm)		Precio (€/ud.)
VS0656708	A	75/50	10	22	52	48	122	20	8,15
VS0656709	B	75/50	4	-	56	42	73	30	7,81
VS0656713	B	90/50	11	-	61	42	78	20	10,81
VS0656715	A	90/75	3	-	57	47	107	20	11,58
VS0656719	B	110/50	20	-	63	42	80	20	11,58
VS0656720	A	110/75	15	28	59	55	142	20	11,92
VS0656721	B	110/75	Z	-	63	47	80	20	11,58
VS0656723	A	110/90	7	3	60	50	113	20	13,21
VS0656729	A	125/110	4	6	67	49	122	20	20,92
VS0656731	B	160/110	10	-	85	52	103	1	31,22
VS0656733	B	160/125	4	-	86	56	105	-	31,22

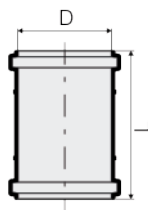

Manguito con tope

Referencia	D (mm)	L (mm)		Precio (€/ud.)
VS0656805	50	105	30	6,09
VS0656807	75	120	20	8,91
VS0656809	90	120	20	12,44
VS0656811	110	136	20	13,81
VS0656813	125	147	20	25,91
VS0656815	160	180	1	39,02

Accesorios

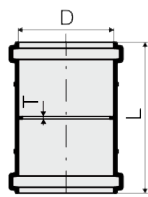

Manguito deslizante 2 bocas

Referencia	D (mm)	L (mm)	T (mm)		Precio (€/ud.)
VS0656855	50	105	2	30	6,09
VS0656857	75	120	2	20	8,91
VS0656859	90	120	3	20	12,44
VS0656861	110	136	3	20	13,81
VS0656863	125	147	3	20	25,91
VS0656865	160	180	3	1	39,02

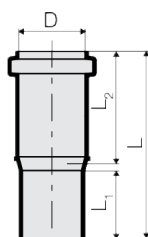

Boca doble profundidad

Referencia	D (mm)	L1 (mm)	L2 (mm)	L (mm)		Precio (€/ud.)
VS0656753	50	48	79	131	20	12,96
VS0656755	75	53	90	150	20	15,17
VS0656757	90	56	95	159	10	19,98
VS0656759	110	63	111	183	10	20,66
VS0656761	125	68	115	195	10	27,28

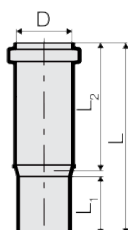

Boca triple profundidad

Referencia	D (mm)	L1 (mm)	L2 (mm)	L (mm)		Precio (€/ud.)
VS0656773	50	48	107	160	20	12,96
VS0656775	75	53	124	183	20	15,17
VS0656777	90	56	129	193	10	19,91
VS0656779	110	61	136	205	20	20,66
VS0656781	125	66	145	220	10	27,28

italsan

Italsan Customer Service
atencionalcliente@italsan.com
Tel. (+34) 900 921 957

www.ital-san.com

Sede Madrid
Tel. (+34) 918 060 723
Oficinas y almacén
Coto de Doñana, 21
28320 Pinto - Madrid

Sede Barcelona
Tel. (+34) 936 303 040
Italsantech
C/ de la Máquina, 8B
Pol. Ind. El Regás
08850 Gavá - Barcelona

Sede Barcelona
Tel. (+34) 936 303 040
Centro logístico
C/ Progrés, 29
Pol. Ind. Les Massotes
08850 Gavá - Barcelona

Italsan Américas
Tel. (+507) 389 79 96
Oficinas y almacén
Vía Panamericana, Sector Pacora
Ofibodegas Las Américas, Bodega n° 9
0832-0588 Panamá City (Panamá)
www.ital-san.com.pa

Italsan Américas RD
Tel. (+507) 6311 7264
Oficinas y almacén
Naves del Canal del Éste Fase II
Nave #368 3
23000 Bávaro (Rep. Dominicana)
www.ital-san.com.pa

Italsan México
Tel. (+55) 8978 4511
Oficina Comercial
Av. Paseo de la Reforma 180 - P14 - Int. A
Colonia Juárez, Cuauhtémoc
06600 Ciudad de México
<https://ital-san.com/es-pa/>

Italsan Chile
Tel. (+56) 2 33242880
Oficinas y almacén
Ciudad de los Valles Trade Center Mód letra I
Calle Los Vientos 19930, Pudahuel
Región Metropolitana - Santiago (Chile)
www.ital-san.cl

Italsan Perú
Tel. (+51) 1 706 32 04
Oficinas
Av. Ricardo Palma, n°341, oficina 304
Urbanización Miraflores · 15058 Lima (Perú)
Almacén
Av. Defensores del Morro 4263, bodega A-02
15058 Chorrillos - Lima (Perú)
www.ital-san.com.pe

Distribuido por:

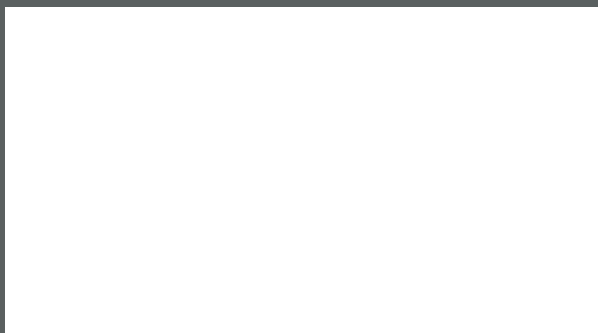

ITALSAN no se responsabiliza de posibles errores que aparezcan en la presente tarifa, y se reserva el derecho de modificar sin previo aviso las características y precios* de los productos.

Para cualquier consulta dirigirse a atencionalcliente@ital-san.com

*Precios sin IVA.

italsantech

ulbios
TTR Test Training & Research
MECHANICAL

valsir
QUALITY FOR PLUMBING

TAR/IVAC/INSONOR/2026/05